

**BOROUGH OF BIG BEAVER  
BEAVER COUNTY, PENNSYLVANIA  
ORDINANCE 248**

**ADOPTION OF THE INTERNATIONAL PROPERTY MAINTENANCE CODE  
ORDINANCE**

AN ORDINANCE of the Borough of Big Beaver adopting the 2024 edition of the International Property Maintenance Code, regulating and governing the conditions and maintenance of all property, buildings and structures; by providing the standards for supplied utilities and facilities and other physical things and conditions essential to ensure that structures are safe, sanitary and fit for occupation and use; and the condemnation of buildings and structures unfit for human occupancy and use, and the demolition of such existing structures in the Borough of Big Beaver; repealing ORDINANCE No. 234 of the Borough of Big Beaver and all other ordinances or parts of laws in conflict therewith.

The Borough of Big Beaver Council of the Borough of Big Beaver does ordain as follows:

**Section 1.** That a certain document, three (3) copies of which are on file in the office of the Borough Secretary of the Borough of Big Beaver being marked and designated as the International Property Maintenance Code, 2024 edition, as published by the International Code Council, be and is hereby adopted as the Property Maintenance Code of the Borough of Big Beaver in the State of Pennsylvania, for regulating and governing the conditions and maintenance of all property, buildings and structures; by providing the standards for supplied utilities and facilities and other physical things and conditions essential to ensure that structures are safe, sanitary and fit for occupation and use; and the condemnation of buildings and structures unfit for human occupancy and use, and the demolition of such existing structures as herein provided; providing for the issuance of permits and collection of fees therefor; and each and all of the regulations, provisions, penalties, conditions and terms of said Property Maintenance Code on file in the office of the Borough of Big Beaver are hereby referred to, adopted, and made a part hereof, as if fully set out in this legislation, with the additions, insertions, deletions and changes, if any, prescribed in Section 2 of this ordinance.

**Section 2.** The following sections are hereby revised:

Section 101.1. Title. These regulations shall be known as the Property Maintenance Code, of Big Beaver Borough hereinafter referred to as "this code."

Section 102.3 Application of other codes. Nothing in this code shall be construed to cancel, modify or set aside any provision of the ~~International Zoning Code~~ Borough of Big Beaver Zoning Ordinance.

Section 102.9 Requirements not covered by code. Requirements necessary for the strength, stability or proper operation of an existing fixture, structure or equipment, or for the public safety, health and general welfare, not specifically covered by this code, shall be determined by the code official ~~and Borough Council~~.

Section 103.1. Creation of agency. The Department of Property Maintenance inspection is hereby created and the official in charge thereof shall be known as the code official.

Section 103.2 Appointment. The code official shall be appointed by the chief appointing authority of the jurisdiction and the code official may be removed from office for cause or without cause.

105.2 Determination of compliance. The code official ~~with the concurrence of Borough Council~~ shall have the authority to determine compliance with this code, to render interpretations of this code and to adopt policies and procedures in order to clarify the application of this code's provisions.

106.1 General. In order to hear and decide appeals of orders, decisions or determinations made by the code official relative to the application and interpretation of this code, is the Beaver County Regional Council Of Governments (COG), ~~there shall be and is hereby created a board of appeals. The board of appeals shall be appointed by the applicable governing authority and shall hold office at its pleasure. The board shall adopt rules of procedure for conducting its business and shall render all decisions and findings in writing to the appellant with a duplicate copy to the code official.~~

106.2 Limitations of authority. An application for appeal shall be based on a claim that the true intent of this code or the rules legally adopted thereunder have been incorrectly interpreted, the provisions of this code do not fully apply or an equivalent or better form of construction is proposed. ~~The board~~ COG shall not have authority to waive requirements of this code.

106.3 Reserved. Qualifications. ~~The board of appeals shall consist of members who are qualified by experience and training on matters pertaining to the provisions of this code and are not employees of the jurisdiction.~~

107.4 Violation penalties. Any person who shall violate a provision of this code, or fail to comply therewith, or with any of the requirements thereof, shall be prosecuted within the limits provided by state or local laws of a summary offense which is no more than a \$300.00 fine and/or imprisonment of ninety (90) days. Each day that a violation continues after due notice has been served shall be deemed a separate offense.

109.2 Closing of vacant structures. If the structure is vacant and unfit for human habitation and occupancy, and is not in danger of structural collapse, the code official is authorized may be authorized by the Borough Council to post a placard of condemnation on the premises and order the structure closed up so as not to be an attractive nuisance.

110.1 Imminent danger. When, in the opinion of the code official and Borough Council consent, there is imminent danger of failure or collapse of a building or structure that endangers life, or when any structure or part of a structure has fallen and life is endangered by the occupation of the structure, or when there is actual or potential danger to the building occupants or those in the proximity of any structure because of explosives, explosive fumes or vapors or the presence of toxic fumes, gases or materials, or operation of defective or dangerous equipment, the code official is hereby authorized and empowered to order and require the occupants to vacate the premises forthwith.

110.2 Temporary safeguards. Notwithstanding other provisions of this code, whenever, in the opinion of the code official and with Borough Council Consent, there is imminent danger due to an unsafe condition, the code official shall order the necessary work to be done, including the boarding up of openings, to render such structure temporarily safe whether or not the legal procedure herein described has been instituted; and shall cause such other action to be taken as the code official deems necessary to meet such emergency.

111.1 General. When the code official determines with the concurrence of Borough Council, any structure is so old, dilapidated or has become so out of repair and is dangerous, unsafe, insanitary and otherwise unfit for human habitation or occupancy the code official can order either of the following:

302.4 Weeds. Premises and exterior property shall be maintained free from weeds or plant growth in excess of fifteen (15) INCHES, excluding undeveloped lots and farms.

Vegetation must remain clear of signs, hydrants, and essential access points on all properties. If growth obstructs sight lines or public safety, the owner must correct it.

302.8 Motor vehicles. Except as provided for in other regulations, not more than one (1), inoperative or unlicensed motor vehicles shall not be parked, kept or stored on any premises, and vehicles shall not at any time be in a state of major disassembly, disrepair, or in the process of being stripped or dismantled. Painting of vehicles is prohibited unless conducted inside an approved spray booth. Exception: A vehicle of any type is permitted to undergo major overhaul,

including body work, provided that such work is performed inside a structure or similarly enclosed area designed and approved for such purposes.

303.2 ~~Reserved~~. Enclosures. Private swimming pools, hot tubs and spas, containing water more than 24 inches (610 mm) in depth shall be completely surrounded by a fence or barrier not less than 48 inches (1219 mm) in height above the finished ground level measured on the side of the barrier away from the pool. Gates and doors in such barriers shall be self-closing and self-latching. Where the self-latching device is less than 54 inches (1372 mm) above the bottom of the gate, the release mechanism shall be located on the pool side of the gate. Self-closing and self-latching gates shall be maintained such that the gate will positively close and latch when released from an open position of 6 inches (152 mm) from the gatepost. An existing pool enclosure shall not be removed, replaced or changed in a manner that reduces its effectiveness as a safety barrier.

304.2 ~~Reserved~~. Protective treatment. **All commercial properties shall adhere to the listed maintenance requirements.** Exterior surfaces, including but not limited to, doors, door and window frames, cornices, porches, trim, balconies, decks and fences, shall be maintained in good condition. Exterior wood surfaces, other than decay-resistant woods, shall be protected from the elements and decay by painting or other protective covering or treatment. Peeling, flaking and chipped paint shall be eliminated and surfaces repainted. Siding and masonry joints, as well as those between the building envelope and the perimeter of windows, doors and skylights, shall be maintained weather resistant and water tight. Metal surfaces subject to rust or corrosion shall be coated to inhibit such rust and corrosion, and surfaces with rust or corrosion shall be stabilized and coated to inhibit future rust and corrosion. Oxidation stains shall be removed from exterior surfaces. Surfaces designed for stabilization by oxidation are exempt from this requirement.

[F] 304.3 ~~Reserved~~. Premises identification. Buildings shall have approved address numbers placed in a position to be plainly legible and visible from the street or road fronting the property. These numbers shall contrast with their background. Address numbers shall be Arabic numerals or alphabet letters. Numbers shall be not less than 4 inches (102 mm) in height with a minimum stroke width of 0.5 inch (12.7 mm).

304.14 ~~Reserved~~. Insect screens. **All commercial properties shall adhere to the listed maintenance requirements.** During the period from **April 1st to October 31st**, every door, window and other outside opening required for ventilation of habitable rooms, food preparation areas, food service areas or any areas where products to be included or utilized in food for human consumption are processed, manufactured, packaged or stored shall be supplied with approved tightly fitting screens of minimum 16 mesh per inch (16 mesh per 25 mm), and every screen door used for insect control shall have a self-closing device in good working condition. Exception: Screens shall not be required where other approved means, such as air curtains or insect repellent fans, are employed.

304.17 ~~Reserved~~. Guards for basement windows. Every basement window that is openable shall be supplied with rodent shields, storm windows or other approved protection against the entry of rodents.

304.18.1 ~~Reserved.~~ Doors. All commercial properties shall adhere to the listed maintenance requirements. Doors providing access to an individual dwelling unit, rooming unit or housekeeping unit that is rented, leased or let where equipped with a deadbolt lock, the deadbolt shall be designed to be readily openable from the side from which egress is to be made without the need for keys, special knowledge or effort and shall have a minimum lock throw of 1 inch (25 mm). Such deadbolt locks shall be installed according to the manufacturer’s specifications and maintained in good working order. For the purpose of this section, a sliding bolt shall not be considered an acceptable deadbolt lock.

304.18.2 ~~Reserved.~~ Windows. Operable windows located in whole or in part within 6 feet (1828 mm) above ground level or a walking surface below that provide access to a dwelling unit, rooming unit or housekeeping unit that is rented, leased or let shall be equipped with a window sash locking device.

304.18.3 ~~Reserved.~~ Basement hatchways. Basement hatchways that provide access to a dwelling unit, rooming unit or housekeeping unit that is rented, leased or let shall be equipped with devices that secure the units from unauthorized entry.

SECTION 307— ~~Reserved.~~ HANDRAILS AND GUARDRAILS 307.1 Handrails. Stairs having more than four risers shall have a handrail on one side of the stair. 307.1.1 Height. Handrails shall be not less than 30 inches (762 mm) in height or more than 42 inches (1067 mm) in height measured vertically above the nosing of the tread or above the finished floor of the landing or walking surfaces. 307.2 Guards. Guards shall be provided along open-sided walking surfaces, including balconies, porches, decks, stairs, ramps and landings, that are more than 30 inches (762 mm) above the floor or grade below. Exception: Guards shall not be required where exempted by the adopted building code. 307.2.1 Height. Guards shall be not less than 30 inches (762 mm) high.

308.3.1 Garbage facilities.-The owner of every dwelling shall supply one of the following: an approved mechanical food waste grinder in each dwelling unit; an approved incinerator unit in the structure available to the occupants in each dwelling unit; or an approved leakproof, covered, outside garbage container.

309.4 Multiple occupancy. The owner of a structure containing two or more dwelling units, a multiple occupancy, a rooming house or a nonresidential structure shall be responsible for pest elimination in the public or shared areas of the structure and exterior property. If infestation is caused by failure of an occupant to prevent such infestation in the area occupied, the occupant and/or owner shall be responsible for pest elimination.

CHAPTER 4 ~~Reserved.~~ LIGHT, VENTILATION AND OCCUPANCY LIMITATIONS

401.1 Scope. The provisions of this chapter shall govern the minimum conditions and standards for light, ventilation and space for occupying a Commercial structure.

602.3 Heat supply. Every owner and operator of any building who rents, leases or lets one or more dwelling units or sleeping units on terms, either expressed or implied, to furnish heat to the

occupants thereof shall supply heat during the period from November to May to maintain a minimum temperature of 68°F (20°C) in all habitable rooms, bathrooms and toilet rooms.

602.4 Occupiable work spaces. Indoor occupiable work spaces shall be supplied with heat during the period from November to May to maintain a minimum temperature of 65°F (18°C) during the period the spaces are occupied.

Appendix A. Reserved. ~~Boarding Standards.~~

Appendix B. Reserved. ~~Board of Appeals.~~

**Section 3.** That ORDINANCE No. **234** of Borough of Borough of Big Beaver entitled PROPERTY MAINTENANCE CODE ORDINANCE AN ORDINANCE ESTABLISHING THE PROPERTY MAINTENANCE CODE and all other ordinances or parts of laws in conflict herewith are hereby repealed.

**Section 4.** That if any section, subsection, sentence, clause or phrase of this legislation is, for any reason, held to be unconstitutional, such decision shall not affect the validity of the remaining portions of this ordinance. The Borough of Big Beaver hereby declares that it would have passed this law, and each section, subsection, clause or phrase thereof, irrespective of the fact that any one or more sections, subsections, sentences, clauses and phrases be declared unconstitutional.

**Section 5.** That nothing in this legislation or in the Property Maintenance Code hereby adopted shall be construed to affect any suit or proceeding impending in any court, or any rights acquired, or liability incurred, or any cause or causes of action acquired or existing, under any act or ordinance hereby repealed as cited in Section 3 of this law; nor shall any just or legal right or remedy of any character be lost, impaired or affected by this legislation.

**Section 6.** That this law and the rules, regulations, provisions, requirements, orders and matters established and adopted hereby shall take effect and be in full force and effect from and after the date of its final passage and adoption.

**Section 7.** That Borough of Big Beaver acknowledges and agrees that the International Code Council, Inc. (“ICC”) owns registered copyrights in the 2024 edition of the ICC International Property Maintenance Code. ICC makes the 2024 edition of the International Property Maintenance Code and numerous other International Codes (I-Codes) available to view for free

on its website at: codes.iccsafe.org. Without separate written permission from the copyright owner, no part of the 2024 edition of the International Property Maintenance Code may be reproduced, distributed or transmitted in any form or by any means, including without limitation, electronic, optical or mechanical means (by way of example, and not limitation, photocopying, or recording by and/or in an information retrieval system). For information on the use rights and permissions, please contact: Publications, 4051 Flossmoor Road, Country Club Hills, IL 60478. Phone 1-888-ICC-SAFE (422-7233).

**ENACTED AND ORDAINED** by the Members of Council of Big Beaver Borough, Beaver County, Pennsylvania, in public meeting this 21st day of April, 2026.

ATTEST:

BIG BEAVER BOROUGH COUNCIL

  
Jennifer Gasser, Secretary

  
Kimberly Wagner, Council President

Read and approved by me, Michelle Joy, Mayor of the Borough of Big Beaver, this 21st day of April, 2026.

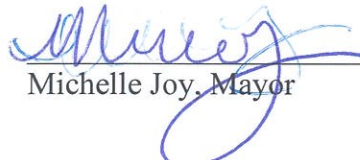
  
Michelle Joy, Mayor

20

24

# IPMC<sup>®</sup>



INTERNATIONAL **PROPERTY**  
**MAINTENANCE** CODE<sup>®</sup>

INTERNATIONAL CODE COUNCIL

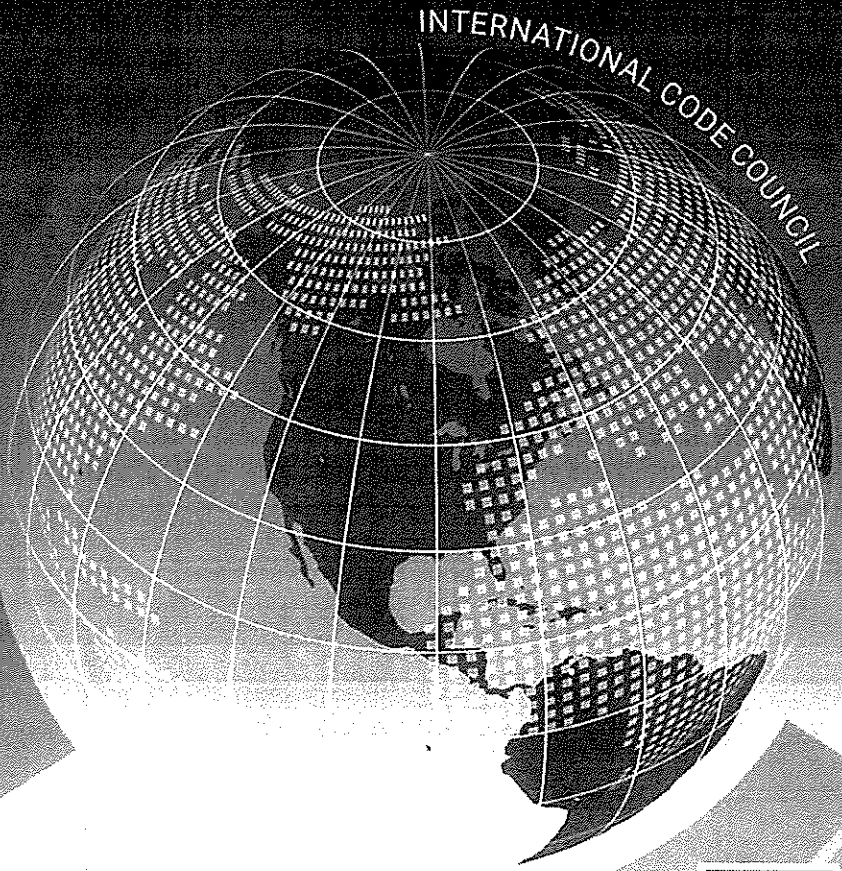

2024

# IPMC<sup>®</sup>



## INTERNATIONAL PROPERTY MAINTENANCE CODE<sup>®</sup>

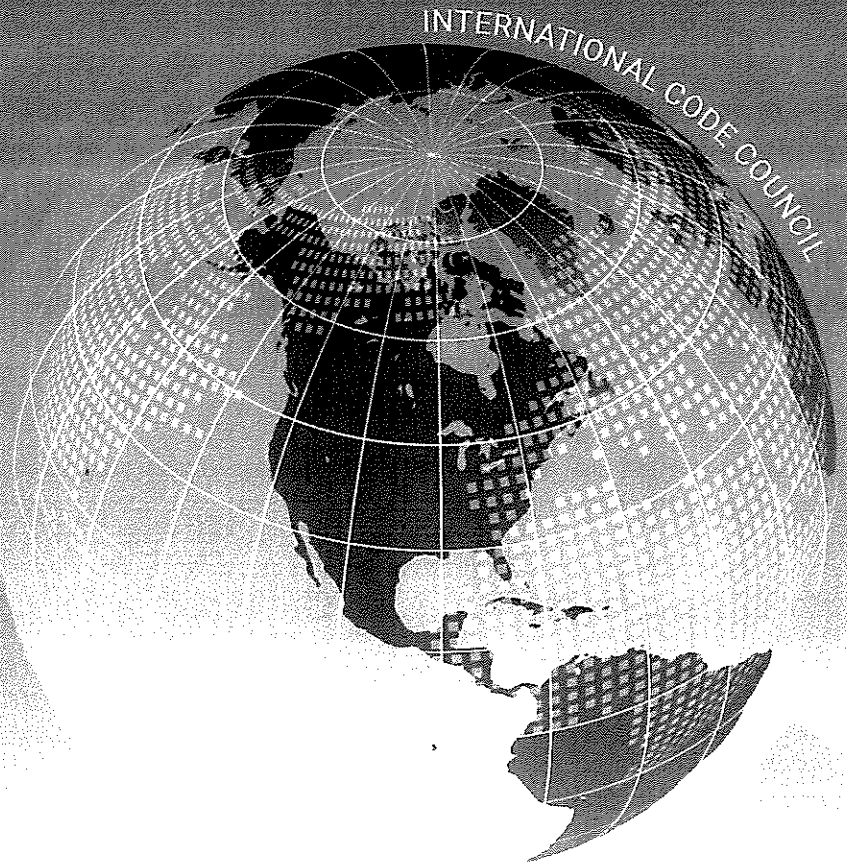

## 2024 International Property Maintenance Code®

First Printing: September 2023  
Second Printing: June 2024

ISBN: 978-1-959851-87-5 (soft-cover edition)  
ISBN: 978-1-959851-88-2 (PDF download)

COPYRIGHT © 2023  
by  
INTERNATIONAL CODE COUNCIL, INC.

ALL RIGHTS RESERVED. This 2024 *International Property Maintenance Code*® is a copyrighted work owned by the International Code Council, Inc. ("ICC"). Without separate written permission from the ICC, no part of this publication may be reproduced, distributed or transmitted in any form or by any means, including, without limitation, electronic, optical or mechanical means (by way of example, and not limitation, photocopying or recording by or in an information storage and/or retrieval system). For information on use rights and permissions, please contact: ICC Publications, 4051 Flossmoor Road, Country Club Hills, Illinois 60478; 1-888-ICC-SAFE (422-7233); <https://www.iccsafe.org/about/periodicals-and-newsroom/icc-logo-license/>.

Trademarks: "International Code Council," the "International Code Council" logo, "ICC," the "ICC" logo, "International Property Maintenance Code," "IPMC" and other names and trademarks appearing in this publication are registered trademarks of the International Code Council, Inc., and/or its licensors (as applicable), and may not be used without permission.

## NEW DESIGN FOR THE 2024 INTERNATIONAL CODES



The 2024 International Codes® (I-Codes®) have undergone substantial formatting changes as part of the digital transformation strategy of the International Code Council® (ICC®) to improve the user experience. The resulting product better aligns the print and PDF versions of the I-Codes with the ICC's Digital Codes® content. The changes, promoting a cleaner, more modern look and enhancing readability and sustainability, include:

Streamlined lists



QR codes to identify code changes more accurately  
(For further details, see *Formatting Changes to the 2024 International Codes.*)

Consistent grouping of associated content  
(e.g., tables immediately follow parent sections)



2024

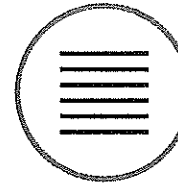

Single-column text

Shading for table headers and notes

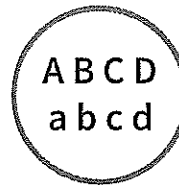
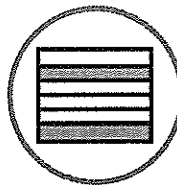

Modernized font styles

More information can be found at [icc.afe.org/design-updates](https://icc.afe.org/design-updates).



## PREFACE

### FORMATTING CHANGES TO THE 2024 INTERNATIONAL CODES

The 2024 International Codes® (I-Codes®) have undergone substantial formatting changes as part of the digital transformation strategy of the International Code Council® (ICC®) to improve the user experience. The resulting product better aligns the print and PDF versions of the I-Codes with the ICC's Digital Code content. Additional information can be found at [iccsafe.org/design-updates](https://iccsafe.org/design-updates).

#### Replacement of Marginal Markings with QR Codes

Through 2021, print editions of the I-Codes identified technical changes from prior code cycles with marginal markings [solid vertical lines for new text, deletion arrows (➡), asterisks for relocations (\*)]. The 2024 I-Code print editions replace the marginal markings with QR codes to identify code changes more precisely.

A QR code is placed at the beginning of any section that has undergone technical revision. If there is no QR code, there are no technical changes to that section.

In the following example from the 2024 *International Property Maintenance Code*® (IPMC®), a QR code indicates there are changes to Section 102 from the 2021 IPMC. Note that the change may occur in the main section or in one or more subsections of the main section.

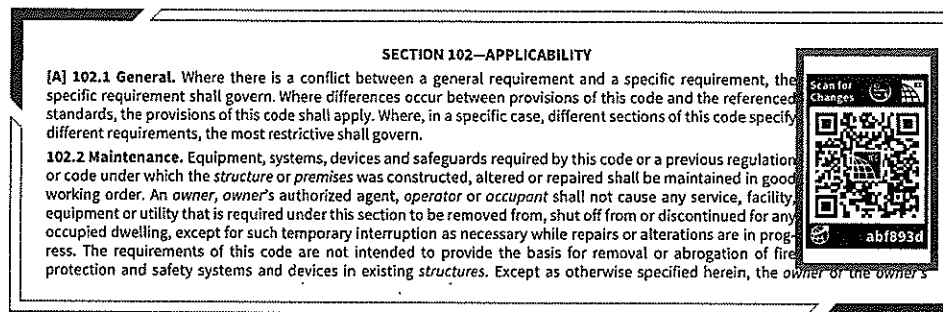

To see the code changes, the user need only scan the QR code with a smart device. If scanning a QR code is not an option, changes can be accessed by entering the 7-digit code beneath the QR code at the end of the following URL: [qr.iccsafe.org/](https://qr.iccsafe.org/) (in the above example, "[qr.iccsafe.org/abf893d](https://qr.iccsafe.org/abf893d)"). Those viewing the code book via PDF can click on the QR code.

All methods take the user to the appropriate section on ICC's Digital Codes website, where technical changes from the prior cycle can be viewed. Digital Codes Premium subscribers who are logged in will be automatically directed to the Premium view. All other users will be directed to the Digital Codes Basic free view. Both views show new code language in blue text along with deletion arrows for deleted text and relocation markers for relocated text.

Digital Codes Premium offers additional ways to enhance code compliance research, including revision histories, commentary by code experts and an advanced search function. A full list of features can be found at [codes.iccsafe.org/premium-features](https://codes.iccsafe.org/premium-features).

### ABOUT THE I-CODES

The 2024 I-Codes, published by the ICC, are 15 fully compatible titles intended to establish provisions that adequately protect public health, safety and welfare; that do not unnecessarily increase construction costs; that do not restrict the use of new materials, products or methods of construction; and that do not give preferential treatment to particular types or classes of materials, products or methods of construction.

The I-Codes are updated on a 3-year cycle to allow for new construction methods and technologies to be incorporated into the codes. Alternative materials, designs and methods not specifically addressed in the I-Code can be approved by the building official where the proposed materials, designs or methods comply with the intent of the provisions of the code.

The I-Codes are used as the basis of laws and regulations in communities across the US and in other countries. They are also used in a variety of nonregulatory settings, including:

- Voluntary compliance programs.
- The insurance industry.
- Certification and credentialing for building design, construction and safety professionals.
- Certification of building and construction-related products.
- Facilities management.
- "Best practices" benchmarks for designers and builders.
- College, university and professional school textbooks and curricula.
- Reference works related to building design and construction.

## Code Development Process

The code development process regularly provides an international forum for building professionals to discuss requirements for building design, construction methods, safety, performance, technological advances and new products. Proposed changes to the I-Codes, submitted by code enforcement officials, industry representatives, design professionals and other interested parties are deliberated through an open code development process in which all interested and affected parties may participate.

Openness, transparency, balance, due process and consensus are the guiding principles of both the ICC Code Development Process and OMB Circular A-119, which governs the federal government's use of private-sector standards. The ICC process is open to anyone without cost. Remote participation is available through *cdpAccess*<sup>®</sup>, the ICC's cloud-based app.

In order to ensure that organizations with a direct and material interest in the codes have a voice in the process, the ICC has developed partnerships with key industry segments that support the ICC's important public safety mission. Some code development committee members were nominated by the following industry partners and approved by the ICC Board:

- American Gas Association (AGA)
- American Institute of Architects (AIA)
- American Society of Plumbing Engineers (ASPE)
- International Association of Fire Chiefs (IAFC)
- National Association of Home Builders (NAHB)
- National Association of State Fire Marshals (NASFM)
- National Council of Structural Engineers Association (NCSEA)
- National Multifamily Housing Council (NMHC)
- Plumbing Heating and Cooling Contractors (PHCC)
- Pool and Hot Tub Alliance (PHTA), formerly The Association of Pool and Spa Professionals (APSP)

Code development committees evaluate and make recommendations regarding proposed changes to the codes. Their recommendations are then subject to public comment and council-wide votes. The ICC's governmental members—public safety officials who have no financial or business interest in the outcome—cast the final votes on proposed changes.

The I-Codes are subject to change through future code development cycles and by any governmental entity that enacts the code into law. For more information regarding the code development process, contact the Codes and Standards Development Department of the ICC at [iccsafe.org/products-and-services/i-codes/code-development/](https://iccsafe.org/products-and-services/i-codes/code-development/).

While the I-Code development procedure is thorough and comprehensive, the ICC, its members and those participating in the development of the codes expressly disclaim any liability resulting from the publication or use of the I-Codes, or from compliance or noncompliance with their provisions. NO WARRANTY OF ANY KIND, IMPLIED, EXPRESSED OR STATUTORY, IS GIVEN WITH RESPECT TO THE I-CODES. The ICC does not have the power or authority to police or enforce compliance with the contents of the I-Codes.

## Code Development Committee Responsibilities (Letter Designations in Front of Section Numbers)

In each cycle, proposed changes are considered by the Code Development Committee assigned to a specific code or subject matter. Committee Action Hearings result in recommendations regarding a proposal to the voting membership. Where changes to a code section are not considered by that code's own committee, the code section is preceded by a bracketed letter designation identifying a different committee. Bracketed letter designations for the I-Code committees are:

- [A] = Administrative Code Development Committee
- [BE] = IBC—Egress Code Development Committee
- [BF] = IBC—Fire Safety Code Development Committee
- [BG] = IBC—General Code Development Committee
- [BS] = IBC—Structural Code Development Committee
- [E] = Developed under the ICC's Standard Development Process
- [EB] = International Existing Building Code Development Committee
- [F] = International Fire Code Development Committee
- [FG] = International Fuel Gas Code Development Committee
- [M] = International Mechanical Code Development Committee
- [P] = International Plumbing Code Development Committee
- [SP] = International Swimming Pool and Spa Code Development Committee

For the development of the 2027 edition of the I-Codes, the ICC Board of Directors approved a standing motion from the Board Committee on the Long-Term Code Development Process to revise the code development cycle to incorporate two committee action hearings for each code group. This change expands the current process from two independent 1-year cycles to a single continuous 3-year cycle. There will be two groups of code development committees and they will meet in separate years. The current groups will be reworked. With the energy provisions of the *International Energy Conservation Code*<sup>®</sup> (IECC<sup>®</sup>) and Chapter 11 of the *International*

## PREFACE

*Residential Code*® (IRC®) now moved to the Code Council's Standards Development Process, the reduced volume of code changes will be distributed between Groups A and B.

Code change proposals submitted for code sections that have a letter designation in front of them will be heard by the respective committee responsible for such code sections. Because different committees hold Committee Action Hearings in different years, proposals for most codes will be heard by committees in both the 2024 (Group A) and the 2025 (Group B) code development cycles. It is very important that anyone submitting code change proposals understands which code development committee is responsible for the section of the code that is the subject of the code change proposal.

Please visit the ICC website at [iccsafe.org/products-and-services/i-codes/code-development/current-code-development-cycle](https://iccsafe.org/products-and-services/i-codes/code-development/current-code-development-cycle) for further information on the Code Development Committee responsibilities as it becomes available.

### Coordination of the I-Codes

The coordination of technical provisions allows the I-Codes to be used as a complete set of complementary documents. Individual codes can also be used in subsets or as stand-alone documents. Some technical provisions that are relevant to more than one subject area are duplicated in multiple model codes.

### Italicized Terms

Words and terms defined in Chapter 2, Definitions, are italicized where they appear in code text and the Chapter 2 definitions apply. Although care has been taken to ensure applicable terms are italicized, there may be instances where a defined term has not been italicized or where a term is italicized but the definition found in Chapter 2 is not applicable. For example, Chapter 2 of the *International Building Code*® (IBC®) contains a definition for "Listed" that is applicable to equipment, products and services. The term "listed" is also used in that code to refer to a list of items within the code or within a referenced document. For the latter, the Chapter 2 definition would not be applicable.

### Adoption of International Code Council Codes and Standards

The International Code Council maintains a copyright in all of its codes and standards. Maintaining copyright allows the Code Council to fund its mission through sales of books in both print and digital format. The Code Council welcomes incorporation by reference of its codes and standards by jurisdictions that recognize and acknowledge the Code Council's copyright in the codes and standards, and further acknowledge the substantial shared value of the public/private partnership for code development between jurisdictions and the Code Council. By making its codes and standards available for incorporation by reference, the Code Council does not waive its copyright in its codes and standards.

The Code Council's codes and standards may only be adopted by incorporation by reference in an ordinance passed by the governing body of the jurisdiction. "Incorporation by reference" means that in the adopting ordinance, the governing body cites only the title, edition, relevant sections or subsections (where applicable), and publishing information of the model code or standard, and the actual text of the model code or standard is not included in the ordinance (see graphic, "Adoption of International Code Council Codes and Standards"). The Code Council does not consent to the reproduction of the text of its codes or standards in any ordinance. If the governing body enacts any changes, only the text of those changes or amendments may be included in the ordinance.



What does "incorporate by reference" mean? If a governmental agency or authority having jurisdiction (AHJ) over code adoption wishes to adopt a model code for legislative or regulatory purposes, it will enact an ordinance, regulation or law to incorporate by reference (IBR) the relevant code. The actual text of the model code is not included in the law, but the enacting law will include the full text of any changes or amendments enacted by the legislative body of the AHJ.

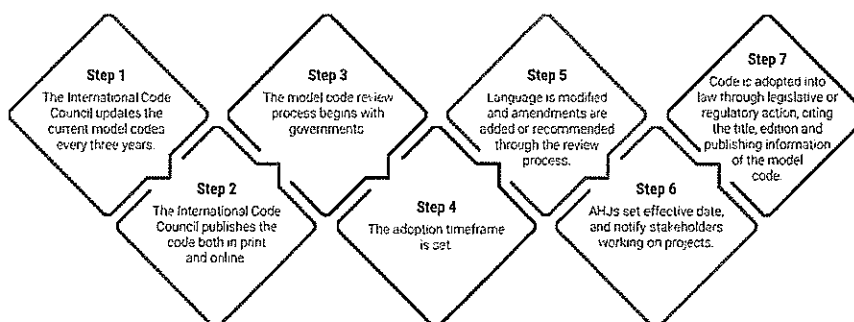

The Code Council also recognizes the need for jurisdictions to make laws accessible to the public. Accordingly, all I-Codes and I-Standards, along with the laws of many jurisdictions, are available to view for free at [codes.iccsafe.org/codes/i-codes](https://codes.iccsafe.org/codes/i-codes). These documents may also be purchased, in both digital and print versions, at [shop.iccsafe.org](https://shop.iccsafe.org).

To facilitate adoption, some I-Code sections contain blanks for fill-in information that needs to be supplied by the adopting jurisdiction as part of the adoption legislation. For example, the IPMC contains:

Section 101.1. Insert: [NAME OF JURISDICTION]

Section 103.1. Insert: [NAME OF DEPARTMENT]

Section 302.4. Insert: [JURISDICTION TO INSERT HEIGHT IN INCHES]

Section 304.14. Insert: [DATES IN TWO LOCATIONS]

Section 602.3. Insert: [DATES IN TWO LOCATIONS]

Section 602.4. Insert: [DATES IN TWO LOCATIONS]

For further information or assistance with adoption, including a sample ordinance, jurisdictions should contact the Code Council at [incorporation@iccsafe.org](mailto:incorporation@iccsafe.org).

For a list of frequently asked questions (FAQs) addressing a range of foundational topics about the adoption of model codes by jurisdictions and to learn more about the Code Council's code adoption resources, scan the QR code or visit [iccsafe.org/code-adoption-resources](https://iccsafe.org/code-adoption-resources).



### INTRODUCTION TO THE INTERNATIONAL PROPERTY MAINTENANCE CODE

The IPMC establishes minimum requirements for the maintenance of existing buildings through model code regulations that contain clear and specific property maintenance and property improvement provisions. The IPMC is a maintenance document intended to establish minimum maintenance standards for basic equipment, light, ventilation, heating, sanitation and fire safety. Responsibility is fixed among owners, operators and occupants for code compliance. The IPMC provides for the regulation and safe use of existing structures in the interest of the social and economic welfare of the community.

### ARRANGEMENT AND FORMAT OF THE 2024 IPMC

Before applying the requirements of the IPMC, it is beneficial to understand its arrangement and format. The IPMC, like other codes published by the ICC, is arranged and organized to follow sequential steps that generally occur during a plan review or inspection.

## PREFACE

The following table shows how the IPMC is divided. The chapter synopses detail the scope and intent of the provisions of the IPMC.

CHAPTER TOPICS	
CHAPTERS	SUBJECTS
1	Scope and Administration
2	Definitions
3	General Requirements
4	Light, Ventilation and Occupancy Limitations
5	Plumbing Facilities and Fixture Requirements
6	Mechanical and Electrical Requirements
7	Fire Safety Requirements
8	Referenced Standards
Appendix A	Boarding Standard
Appendix B	Board of Appeals

### Chapter 1 Scope and Administration.

Chapter 1 establishes the limits of applicability of the code and describes how the code is to be applied and enforced. The provisions of Chapter 1 establish the authority and duties of the code official appointed by the authority having jurisdiction and also establish the rights and privileges of the design professional, contractor and property owner.

### Chapter 2 Definitions.

Chapter 2 is the repository of the definitions of terms used in the body of the code. The user of the code should be familiar with and consult this chapter because the definitions are essential to the correct interpretation of the code and because the user may not be aware that a term is defined.

### Chapter 3 General Requirements.

Chapter 3 includes a variety of requirements for the exterior property areas as well as the interior and exterior elements of the structure that are intended to maintain a minimum level of safety and sanitation for both the general public and the occupants of a structure. Chapter 3 provides specific criteria for regulating the maintenance of specific building components; vacant structures and land; interior and exterior of structures and all exterior property areas; and accessory structures. This chapter also contains requirements for protective barriers, and gates therein, for swimming pools, spas and hot tubs.

### Chapter 4 Light, Ventilation and Occupancy Limitations.

Chapter 4 establishes the minimum environment for occupiable and habitable buildings through light and ventilation criteria and occupancy limitations based on room width, area and ceiling height.

### Chapter 5 Plumbing Facilities and Fixture Requirements.

Chapter 5 establishes requirements for the installation, maintenance and location of plumbing systems and facilities, including the water supply system, water heating appliances, sewage disposal system and related plumbing fixtures. Chapter 5 establishes these minimum criteria to verify that sanitary and clean conditions related to plumbing systems and facilities are maintained throughout the life of a building.

### Chapter 6 Mechanical and Electrical Requirements.

Chapter 6 establishes minimum criteria for the installation and maintenance of the following components and systems within existing buildings: heating and air-conditioning equipment, appliances and their supporting systems; water heating equipment, appliances and systems; cooking equipment and appliances; ventilation and exhaust equipment; gas and liquid fuel distribution piping and components; fireplaces and solid fuel-burning appliances; chimneys and vents; electrical services; lighting fixtures; electrical receptacle outlets; electrical distribution system equipment, devices and wiring; and elevators, escalators and dumbwaiters.

### Chapter 7 Fire Safety Requirements.

Chapter 7 addresses fire hazards associated with a building's occupancy and provides minimum requirements for fire safety issues most likely to arise in older buildings. This chapter also contains requirements for means of egress in existing buildings, including path of travel, required egress width, means of egress doors and emergency escape openings.

**Chapter 8 Referenced Standards.**

Chapter 8 lists all of the product and installation standards and codes that are referenced throughout Chapters 1 through 7 and includes identification of the promulgators and the section numbers in which the standards and codes are referenced. As stated in Section 102.8, these standards and codes become an enforceable part of the code (to the prescribed extent of the reference) as if printed in the body of the code.

**Appendix A Boarding Standard.**

The provisions in Appendix A are not mandatory unless specifically referenced in the adopting ordinance. This appendix provides minimum specifications for boarding a structure. This can be utilized by a jurisdiction as a set of minimum requirements in order to result in consistent boarding quality.

**Appendix B Board of Appeals.**

Appendix B contains the provisions for appeal and the establishment of a board of appeals. The provisions include the application for an appeal, the makeup of the board of appeals and the conduct of the appeal process.

**RELOCATION OF TEXT OR TABLES**

The following table indicates relocation of sections and tables in the 2024 edition of the IPCM from the 2021 edition.

RELOCATION	
2024 LOCATION	2021 LOCATION
105.2.1.4	106.3.1
105.2.2	106.2
105.2.2.6	106.6
105.2.3	106.1
105.6.4	106.3.2
105.8	106.5
105.8.1	106.4
106	107
107	109
108	110
109	111
110	112
111	113

## CONTENTS

<b>CHAPTER 1 SCOPE AND ADMINISTRATION</b> . . . . .	<b>9</b>	<b>CHAPTER 6 MECHANICAL AND ELECTRICAL REQUIREMENTS</b> . . . . .	<b>31</b>
<i>PART 1—SCOPE AND APPLICATION</i> . . . . .	9	601 General . . . . .	31
101 Scope and General Requirements . . . . .	9	602 Heating Facilities . . . . .	31
102 Applicability . . . . .	9	603 Mechanical Equipment . . . . .	31
<i>PART 2—ADMINISTRATION AND ENFORCEMENT</i> . . . . .	10	604 Electrical Facilities . . . . .	32
103 Code Compliance Agency . . . . .	10	605 Electrical Equipment . . . . .	32
104 Fees . . . . .	10	606 Elevators, Escalators and Dumbwaiters . . . . .	33
105 Duties and Powers of the Code Official . . . . .	10	607 Duct Systems . . . . .	33
106 Means of Appeals . . . . .	12		
107 Violations . . . . .	12	<b>CHAPTER 7 FIRE SAFETY REQUIREMENTS</b> . . . . .	<b>34</b>
108 Stop Work Order . . . . .	13	701 General . . . . .	34
109 Unsafe Structures and Equipment . . . . .	13	702 Means of Egress . . . . .	34
110 Emergency Measures . . . . .	15	703 Fire-Resistance Ratings . . . . .	34
111 Demolition . . . . .	15	704 Fire Protection Systems . . . . .	35
		705 Carbon Monoxide Alarms and Detection . . . . .	38
<b>CHAPTER 2 DEFINITIONS</b> . . . . .	<b>17</b>	<b>CHAPTER 8 REFERENCED STANDARDS</b> . . . . .	<b>39</b>
201 General . . . . .	17	<b>APPENDIX A BOARDING STANDARD</b> . . . . .	<b>41</b>
202 General Definitions . . . . .	17	A101 General . . . . .	41
<b>CHAPTER 3 GENERAL REQUIREMENTS</b> . . . . .	<b>20</b>	A102 Materials . . . . .	41
301 General . . . . .	20	A103 Installation . . . . .	41
302 Exterior Property Areas . . . . .	20	A104 Referenced Standard . . . . .	42
303 Swimming Pools, Spas and Hot Tubs . . . . .	21	<b>APPENDIX B BOARD OF APPEALS</b> . . . . .	<b>43</b>
304 Exterior Structure . . . . .	21	B101 General . . . . .	43
305 Interior Structure . . . . .	23	<b>INDEX</b> . . . . .	<b>45</b>
306 Component Serviceability . . . . .	23		
307 Handrails and Guardrails . . . . .	25		
308 Rubbish and Garbage . . . . .	25		
309 Pest Elimination . . . . .	25		
310 Accessibility . . . . .	25		
311 Storm Shelters . . . . .	25		
<b>CHAPTER 4 LIGHT, VENTILATION AND OCCUPANCY LIMITATIONS</b> . . . . .	<b>26</b>		
401 General . . . . .	26		
402 Light . . . . .	26		
403 Ventilation . . . . .	26		
404 Occupancy Limitations . . . . .	27		
<b>CHAPTER 5 PLUMBING FACILITIES AND FIXTURE REQUIREMENTS</b> . . . . .	<b>29</b>		
501 General . . . . .	29		
502 Required Facilities . . . . .	29		
503 Toilet Rooms . . . . .	29		
504 Plumbing Systems and Fixtures . . . . .	29		
505 Water System . . . . .	30		
506 Sanitary Drainage System . . . . .	30		
507 Storm Drainage . . . . .	30		

## SCOPE AND ADMINISTRATION

**User notes:****About this chapter:**

Chapter 1 establishes the limits of applicability of the code and describes how the code is to be applied and enforced. Chapter 1 is in two parts: Part 1—Scope and Application (Sections 101 and 102) and Part 2—Administration and Enforcement (Sections 103–111). Section 101 identifies which buildings and structures come under its purview and references other I-Codes as applicable.

This code is intended to be adopted as a legally enforceable document and it cannot be effective without adequate provisions for its administration and enforcement. The provisions of Chapter 1 establish the authority and duties of the code official appointed by the authority having jurisdiction and also establish the rights and privileges of the property owner and building occupants.

Sections 105 and 106 have been extensively reorganized for the 2024 edition. For clarity, the relocation marginal markings have not been included. For complete information, see the Relocations table in the Preface information of this code.

**QR code use:**

A QR code is placed at the beginning of any section that has undergone technical revision. To see those revisions, scan the QR code with a smart device or enter the 7-digit code beneath the QR code at the end of the following URL: [qr.iccsafe.org/](http://qr.iccsafe.org/) (see Formatting Changes to the 2024 International Codes for more information).

## PART 1 — SCOPE AND APPLICATION

## SECTION 101—SCOPE AND GENERAL REQUIREMENTS

**[A] 101.1 Title.** These regulations shall be known as the *Property Maintenance Code* of [NAME OF JURISDICTION], hereinafter referred to as “this code.”

**[A] 101.2 Scope.** The provisions of this code shall apply to all existing residential and nonresidential *structures* and all existing *premises* and constitute minimum requirements and standards for *premises, structures, equipment and facilities* for light, *ventilation*, space, heating, sanitation, protection from the elements, a reasonable level of safety from fire and other hazards, and for a reasonable level of sanitary maintenance; the responsibility of *owners, an owner’s authorized agent, operators and occupants*; the *occupancy* of existing *structures and premises*, and for administration, enforcement and penalties.

**101.2.1 Appendices.** Provisions in the appendices shall not apply unless specifically adopted.

**[A] 101.3 Purpose.** The purpose of this code is to establish minimum requirements to provide a reasonable level of health, safety, property protection and general welfare insofar as they are affected by the continued *occupancy* and maintenance of *structures and premises*. Existing *structures and premises* that do not comply with these provisions shall be altered or repaired to provide a reasonable minimum level of health, safety and general welfare as required herein.

**[A] 101.4 Severability.** If a section, subsection, sentence, clause or phrase of this code is, for any reason, held to be unconstitutional, such decision shall not affect the validity of the remaining portions of this code.



## SECTION 102—APPLICABILITY

**[A] 102.1 General.** Where there is a conflict between a general requirement and a specific requirement, the specific requirement shall govern. Where differences occur between provisions of this code and the referenced standards, the provisions of this code shall apply. Where, in a specific case, different sections of this code specify different requirements, the most restrictive shall govern.

**102.2 Maintenance.** Equipment, systems, devices and safeguards required by this code or a previous regulation or code under which the *structure or premises* was constructed, altered or repaired shall be maintained in good working order. An *owner, owner’s authorized agent, operator or occupant* shall not cause any service, facility, equipment or utility that is required under this section to be removed from, shut off from or discontinued for any occupied dwelling, except for such temporary interruption as necessary while repairs or alterations are in progress. The requirements of this code are not intended to provide the basis for removal or abrogation of fire protection and safety systems and devices in existing *structures*. Except as otherwise specified herein, the *owner or the owner’s authorized agent* shall be responsible for the maintenance of buildings, *structures and premises*.

**[A] 102.3 Application of other codes.** Repairs, additions or alterations to a *structure*, or changes of *occupancy*, shall be done in accordance with the procedures and provisions of the *International Building Code, International Existing Building Code, International Energy Conservation Code, International Fire Code, International Fuel Gas Code, International Mechanical Code, International Residential Code, International Plumbing Code* and NFPA 70. Nothing in this code shall be construed to cancel, modify or set aside any provision of the *International Zoning Code*.

**[A] 102.4 Existing remedies.** The provisions in this code shall not be construed to abolish or impair existing remedies of the jurisdiction or its officers or agencies relating to the removal or demolition of any *structure* that is *dangerous, unsafe or insanitary*.



## SCOPE AND ADMINISTRATION

[A] **102.5 Workmanship.** Repairs, maintenance work, alterations or installations that are caused directly or indirectly by the enforcement of this code shall be executed and installed in a *workmanlike* manner and installed in accordance with the manufacturer's instructions.

**102.6 Structural analysis.** Where structural analysis is used to assess a potentially unsafe structural condition, the analysis shall be permitted to use nominal strengths, nominal loads, load effects, required strengths and limit states in accordance with the requirements under which the *structure* was constructed or in accordance with any subsequent requirement.

[A] **102.7 Historic buildings.** The provisions of this code shall not be mandatory for existing buildings or *structures* designated as historic buildings where such buildings or *structures* are judged by the *code official* to be safe and in the public interest of health, safety and welfare.

[A] **102.8 Referenced codes and standards.** The codes and standards referenced in this code shall be those that are listed in Chapter 8 and considered part of the requirements of this code to the prescribed extent of each such reference and as further regulated in Sections 102.8.1 and 102.8.2.

**Exception:** Where enforcement of a code provision would violate the conditions of the listing of the equipment or appliance, the conditions of the listing shall apply.

[A] **102.8.1 Conflicts.** Where conflicts occur between provisions of this code and the referenced standards, the provisions of this code shall apply.

[A] **102.8.2 Provisions in referenced codes and standards.** Where the extent of the reference to a referenced code or standard includes subject matter that is within the scope of this code, the provisions of this code, as applicable, shall take precedence over the provisions in the referenced code or standard.

[A] **102.9 Requirements not covered by code.** Requirements necessary for the strength, stability or proper operation of an existing fixture, *structure* or equipment, or for the public safety, health and general welfare, not specifically covered by this code, shall be determined by the *code official*.

[A] **102.10 Application of references.** References to chapter or section numbers, or to provisions not specifically identified by number, shall be construed to refer to such chapter, section or provision of this code.

[A] **102.11 Other laws.** The provisions of this code shall not be deemed to nullify any provisions of local, state or federal law.

## PART 2 — ADMINISTRATION AND ENFORCEMENT

### SECTION 103—CODE COMPLIANCE AGENCY

[A] **103.1 Creation of agency.** The [INSERT NAME OF DEPARTMENT] is hereby created and the official in charge thereof shall be known as the *code official*. The function of the agency shall be the implementation, administration and enforcement of the provisions of this code.

[A] **103.2 Appointment.** The *code official* shall be appointed by the chief appointing authority of the jurisdiction.

[A] **103.3 Deputies.** In accordance with the prescribed procedures of this jurisdiction and with the concurrence of the appointing authority, the *code official* shall have the authority to appoint a deputy *code official*, other related technical officers, inspectors and other employees. Such employees shall have powers as delegated by the *code official*.

### SECTION 104—FEES

[A] **104.1 Fees.** The fees for activities and services performed by the department in carrying out its responsibilities under this code shall be as established by the applicable governing authority.

**104.2 Refunds.** The *code official* is authorized to establish a refund policy.

### SECTION 105—DUTIES AND POWERS OF THE CODE OFFICIAL



[A] **105.1 General.** The *code official* is hereby authorized and directed to enforce the provisions of this code.

[A] **105.2 Determination of compliance.** The *code official* shall have the authority to determine compliance with this code, to render interpretations of this code and to adopt policies and procedures in order to clarify the application of this code's provisions. Such interpretations, policies and procedures:

1. Shall be in compliance with the intent and purpose of this code.
2. Shall not have the effect of waiving requirements specifically provided for in this code or other applicable codes and ordinances.

[A] **105.2.1 Technical assistance.** To determine compliance with this code, the *code official* is authorized to require the owner or owner's authorized agent to provide a technical opinion and report.

[A] **105.2.1.1 Cost.** A technical opinion and report shall be provided without charge to the jurisdiction.

[A] **105.2.1.2 Preparer qualifications.** The technical opinion and report shall be prepared by a qualified engineer, specialist, laboratory or specialty organization acceptable to the *code official*. The *code official* is authorized to require design submittals to be prepared by, and bear the stamp of, a registered design professional.

**[A] 105.2.1.3 Content.** The technical opinion and report shall analyze the properties of the design, operation or use of the building or premises and the facilities and appurtenances situated thereon to identify and propose necessary recommendations.

**[A] 105.2.1.4 Test methods.** Where there is insufficient evidence of compliance with the provisions of this code, the code official shall have the authority to require tests as evidence of compliance. Test methods shall be as specified in this code or by other recognized test standards. In the absence of recognized test standards, the *code official* shall approve the testing procedures. Such tests shall be performed by a party acceptable to the code official.

**[A] 105.2.2 Alternative materials, design and methods of construction and equipment.** The provisions of this code are not intended to prevent the installation of any material or to prohibit any design or method of construction not specifically prescribed by this code, provided that any such alternative is not specifically prohibited by this code and has been *approved*.

**Exception:** Performance-based alternative materials, designs or methods of construction and equipment complying with the *International Code Council Performance Code*.

**[A] 105.2.2.1 Approval authority.** An alternative material, design or method of construction shall be approved where the code official finds that the proposed alternative is satisfactory and complies with Sections 105.2.2 through 105.2.2.7, as applicable.

**[A] 105.2.2.2 Application and disposition.** Where required, a request to use an alternative material, design or method of construction shall be submitted in writing to the code official for approval. Where the alternative material, design or method of construction is not approved, the code official shall respond in writing, stating the reasons the alternative was not approved.

**[A] 105.2.2.3 Compliance with code intent.** An alternative material, design or method of construction shall comply with the intent of the provisions of this code.

**[A] 105.2.2.4 Equivalency criteria.** An alternative material, design or method of construction shall, for the purpose intended, be not less than the equivalent of that prescribed in this code with respect to all of the following, as applicable:

1. Quality.
2. Strength.
3. Effectiveness.
4. Durability.
5. Safety, other than fire safety.
6. Fire safety.

**[A] 105.2.2.5 Tests.** Tests conducted to demonstrate equivalency in support of an alternative material, design or method of construction application shall be of a scale that is sufficient to predict performance of the end use configuration. Tests shall be performed by a party acceptable to the code official.

**[A] 105.2.2.5.1 Fire tests.** Tests conducted to demonstrate equivalent fire safety in support of an alternative material, design or method of construction application shall be of a scale that is sufficient to predict fire safety performance of the end use configuration. Tests shall be performed by a party acceptable to the building official.

**[A] 105.2.2.6 Reports.** Supporting documentation, where necessary to assist in the approval of materials or assemblies not specifically provided for in this code, shall comply with Sections 105.2.2.6.1 and 105.2.2.6.2.

**[A] 105.2.2.6.1 Evaluation reports.** Evaluation reports shall be issued by an approved agency and use of the evaluation report shall require approval by the code official for the installation. The alternate material, design or method of construction and product evaluated shall be within the scope of the code official's recognition of the approved agency. Criteria used for the evaluation shall be identified within the report and, where required, provided to the code official.

**[A] 105.2.2.6.2 Other reports.** Reports not complying with Section 105.2.2.6.1 shall describe criteria, including but not limited to any referenced testing or analysis, used to determine compliance with code intent and justify code equivalence. The report shall be prepared by a qualified engineer, specialist, laboratory or specialty organization acceptable to the building official. The code official is authorized to require design submittals to be prepared by, and bear the stamp of, a registered design professional.

**[A] 105.2.2.7 Peer review.** The code official is authorized to require submittal of a peer review report in conjunction with a request to use an alternative material, design or method of construction, prepared by a peer reviewer that is approved by the code official.

**[A] 105.2.3 Modifications.** Where there are practical difficulties involved in carrying out the provisions of this code, the *code official* shall have the authority to grant modifications for individual cases, provided that the *code official* shall first find that special individual reasons make the strict letter of this code impractical, and that the modification is in compliance with the intent and purpose of this code and that such modification does not lessen health, accessibility, life and fire safety or structural requirements. The details of the written request for and action granting modifications shall be recorded and entered in the files of the department of building safety.

**[A] 105.3 Right of entry.** Where it is necessary to make an inspection to enforce the provisions of this code, or where the *code official* has reasonable cause to believe that there exists in a *structure* or on any *premises* a condition that is contrary to or in violation of this code that makes the structure or premises unsafe, dangerous or hazardous, the *code official* is authorized to enter the *structure* or *premises* at all reasonable times to inspect or perform the duties imposed by this code. If such *structure* or *premises* is occupied, the *code*

## SCOPE AND ADMINISTRATION

*official* shall present credentials to the *occupant* and request entry. If such *structure* or *premises* is unoccupied, the *code official* shall first make a reasonable effort to locate the *owner*, *owner's* authorized agent or other *person* having charge or control of the *structure* or *premises* and request entry. If entry is refused, the *code official* shall have recourse to every remedy provided by law to secure entry.

**105.3.1 Warrant.** Where the *code official* has first obtained a proper inspection warrant or other remedy provided by law to secure entry, an owner, the owner's authorized agent, occupant or *person* having charge, care or control of the *structure* or *premises* shall not fail or neglect, after proper a request is made as herein provided, to permit entry therein by the *code official* for the purposes of inspection and examination pursuant to this code.

**[A] 105.4 Identification.** The *code official* shall carry proper identification when inspecting *structures* or *premises* in the performance of duties under this code.

**[A] 105.5 Notices and orders.** The *code official* shall issue all necessary notices or orders to ensure compliance with this code, in accordance with Section 107.

**[A] 105.6 Official records.** The *code official* shall keep official records as required by Sections 105.6.1 through 105.6.5. Such official records shall be retained for not less than 5 years or for as long as the building or structure to which such records relate remains in existence, unless otherwise provided by other regulations.

**[A] 105.6.1 Approvals.** A record of approvals shall be maintained by the *code official* and shall be available for public inspection during business hours in accordance with applicable laws.

**[A] 105.6.2 Inspections.** The *code official* shall have the authority to conduct inspections, or shall accept reports of inspection by approved agencies or individuals. Reports of such inspections shall be in writing and be certified by a responsible officer of such approved agency or by the responsible individual. The *code official* shall keep a record of each inspection made, including notices and orders issued, showing the findings and disposition of each.

**[A] 105.6.3 Code alternatives and modifications.** Application for alternative materials, design and methods of construction and equipment in accordance with Section 105.2.2; modifications in accordance with Section 105.2.3; and documentation of the final decision of the *code official* for either shall be in writing and shall be retained in the official records.

**[A] 105.6.4 Tests.** The *code official* shall keep a record of tests conducted to comply with Sections 105.2.1.4 and 105.2.2.5.

**[A] 105.6.5 Fees.** The *code official* shall keep a record of fees collected and refunded in accordance with Section 104.

**[A] 105.7 Liability.** The *code official*, member of the board of appeals or employee charged with the enforcement of this code, while acting for the jurisdiction, in good faith and without malice in the discharge of the duties required by this code or other pertinent law or ordinance, shall not thereby be rendered personally liable, either civilly or criminally, and is hereby relieved from personal liability for any damage accruing to *persons* or property as a result of an act or by reason of any act or omission in the discharge of official duties.

**[A] 105.7.1 Legal defense.** Any suit or criminal complaint instituted against any officer or employee because of an act performed by that officer or employee in the lawful discharge of duties and under the provisions of this code or other laws or ordinances implemented through the enforcement of this code shall be defended by the legal representative of the jurisdiction until the final termination of the proceedings. The *code official* or any subordinate shall not be liable for costs in an action, suit or proceeding that is instituted in pursuance of the provisions of this code.

**[A] 105.8 Approved materials and equipment.** Materials, equipment and devices *approved* by the *code official* shall be constructed and installed in accordance with such approval.

**[A] 105.8.1 Materials and equipment reuse.** Materials, equipment and devices shall not be reused unless such elements are in good working condition and approved.

## 106—MEANS OF APPEALS



**106.1 General.** In order to hear and decide appeals of orders, decisions or determinations made by the *code official* relative to the application and interpretation of this code, there shall be and is hereby created a board of appeals. The board of appeals shall be appointed by the applicable governing authority and shall hold office at its pleasure. The board shall adopt rules of procedure for conducting its business and shall render all decisions and findings in writing to the appellant with a duplicate copy to the *code official*.

**[A] 106.2 Limitations of authority.** An application for appeal shall be based on a claim that the true intent of this code or the rules legally adopted thereunder have been incorrectly interpreted, the provisions of this code do not fully apply or an equivalent or better form of construction is proposed. The board shall not have authority to waive requirements of this code.

**106.3 Qualifications.** The board of appeals shall consist of members who are qualified by experience and training on matters pertaining to the provisions of this code and are not employees of the jurisdiction.

**106.4 Administration.** The *code official* shall take action without delay in accordance with the decision of the board.

## 107—VIOLATIONS

**[A] 107.1 Unlawful acts.** It shall be unlawful for a *person*, firm or corporation to be in conflict with or in violation of any of the provisions of this code.

**[A] 107.2 Notice of violation.** The *code official* shall serve a notice of violation or order in accordance with Section 109.4.

**[A] 107.3 Prosecution of violation.** Any person failing to comply with a notice of violation or order served in accordance with Section 109.4 shall be deemed guilty of a misdemeanor or civil infraction as determined by the local municipality, and the violation shall be deemed a *strict liability offense*. If the notice of violation is not complied with, the *code official* shall institute the appropriate proceeding at law or in equity to restrain, correct or abate such violation, or to require the removal or termination of the unlawful occupancy of the structure in violation of the provisions of this code or of the order or direction made pursuant thereto. Any action taken by the authority having jurisdiction on such premises shall be charged against the real estate upon which the structure is located and shall be a lien upon such real estate.

**[A] 107.4 Violation penalties.** Any person who shall violate a provision of this code, or fail to comply therewith, or with any of the requirements thereof, shall be prosecuted within the limits provided by state or local laws. Each day that a violation continues after due notice has been served shall be deemed a separate offense.

**[A] 107.5 Abatement of violation.** The imposition of the penalties herein prescribed shall not preclude the legal officer of the jurisdiction from instituting appropriate action to restrain, correct or abate a violation, or to prevent illegal occupancy of a building, structure or premises, or to stop an illegal act, conduct, business or utilization of the building, structure or premises.

## 108—STOP WORK ORDER

**[A] 108.1 Authority.** Where the *code official* finds any work regulated by this code being performed in a manner contrary to the provisions of this code or in an unsafe manner, the *code official* is authorized to issue a stop work order.

**[A] 108.2 Issuance.** The stop work order shall be in writing and shall be given to the *owner* of the property, to the *owner's* authorized agent, or to the *person* performing the work. Upon issuance of a stop work order, the cited work shall immediately cease. The stop work order shall state the reason for the order and the conditions under which the cited work is authorized to resume.

**[A] 108.3 Emergencies.** Where an emergency exists, the *code official* shall not be required to give a written notice prior to stopping the work.

**[A] 108.4 Failure to comply.** Any person who shall continue any work after having been served with a stop work order, except such work as that person is directed to perform to remove a violation or unsafe condition, shall be subject to fines established by the authority having jurisdiction.



## 109—UNSAFE STRUCTURES AND EQUIPMENT

**109.1 Unsafe conditions.** When a structure or equipment is found by the *code official* to be unsafe, or when a structure is found unfit for human occupancy, or is found unlawful, such structure shall be *condemned* pursuant to the provisions of this code.

**109.1.1 Unsafe structures.** An unsafe structure is one that is found to be hazardous to the life, health, property or safety of the public or the occupants of the structure by not providing minimum safeguards to protect or warn occupants in the event of fire, or because such structure contains unsafe equipment or is dangerous.

**109.1.2 Unsafe equipment.** Unsafe equipment includes any boiler, heating equipment, elevator, moving stairway, electrical wiring or device, flammable liquid containers or other equipment on the premises or within the structure that is in such disrepair or condition that such equipment is a hazard to life, health, property or safety of the public or occupants of the premises or structure.

**109.1.3 Structure unfit for human occupancy.** A structure is unfit for human occupancy whenever the *code official* finds that such structure is unsafe, unlawful or, because of the degree to which the structure is in disrepair or lacks maintenance, is insanitary, vermin or rat infested, contains filth and contamination, or lacks ventilation, illumination, sanitary or heating facilities or other essential equipment required by this code, or because the location of the structure constitutes a hazard to the occupants of the structure or to the public.

**109.1.4 Unlawful structure.** An unlawful structure is one found in whole or in part to be occupied by more persons than permitted under this code, or was erected, altered or occupied contrary to law.

**109.1.5 Hazardous structure or premises.** For the purpose of this code, any structure or premises that has any or all of the conditions or defects described as follows shall be considered to be hazardous:

1. Any door, aisle, passageway, stairway, exit or other means of egress that does not conform to the approved building or fire code of the jurisdiction as related to the requirements for existing buildings.
2. The walking surface of any aisle, passageway, stairway, exit or other means of egress is so warped, worn loose, torn or otherwise unsafe as to not provide safe and adequate means of egress.
3. Any building, structure or portion thereof that is dangerous.
4. The building or structure, or any portion thereof, is clearly unsafe for its use and occupancy.
5. The building or structure is neglected, damaged, dilapidated, unsecured or abandoned so as to become an attractive nuisance to children who might play in the building or structure to their danger, becomes a harbor for vagrants, criminals or immoral persons, or enables persons to resort to the building or structure for committing a nuisance or an unlawful act.



## SCOPE AND ADMINISTRATION

6. Any building or *structure* has been constructed, exists or is maintained in violation of any specific requirement or prohibition applicable to such building or *structure* provided by the *approved* building or fire code of the jurisdiction, or of any law or ordinance to such an extent as to present either a substantial risk of fire, building collapse or any other threat to life and safety.
7. A building or *structure*, used or intended to be used for dwelling purposes, because of inadequate maintenance, dilapidation, decay, damage, faulty construction or arrangement, inadequate light, *ventilation*, mechanical or plumbing system, or otherwise, is determined by the *code official* to be unsanitary, unfit for human habitation or in such a condition that is likely to cause sickness or disease.
8. Any building or *structure*, because of a lack of sufficient or proper fire-resistance-rated construction, fire protection systems, electrical system, fuel connections, mechanical system, plumbing system or other cause, is determined by the *code official* to be a threat to life or health.
9. Any portion of a building remains on a site after the demolition or destruction of the building or *structure* or whenever any building or *structure* is abandoned so as to constitute such building or portion thereof as an attractive nuisance or hazard to the public.

**109.2 Closing of vacant structures.** If the *structure* is vacant and unfit for human habitation and *occupancy*, and is not in danger of structural collapse, the *code official* is authorized to post a placard of condemnation on the *premises* and order the *structure* closed up so as not to be an attractive nuisance. Upon failure of the *owner* or *owner's* authorized agent to close up the *premises* within the time specified in the order, the *code official* shall cause the *premises* to be closed and secured through any available public agency or by contract or arrangement by private persons and the cost thereof shall be charged against the real estate upon which the *structure* is located and shall be a lien upon such real estate and shall be collected by any other legal resource.

**109.2.1 Authority to disconnect service utilities.** The *code official* shall have the authority to authorize disconnection of utility service to the building, *structure* or system regulated by this code and the referenced codes and standards set forth in Section 102.8 in case of emergency where necessary to eliminate an immediate hazard to life or property or where such utility connection has been made without approval. The *code official* shall notify the serving utility and, whenever possible, the *owner* or *owner's* authorized agent and *occupant* of the building, *structure* or service system of the decision to disconnect prior to taking such action. If not notified prior to disconnection the *owner*, *owner's* authorized agent or *occupant* of the building *structure* or service system shall be notified in writing as soon as practical thereafter.

**109.3 Record.** The *code official* shall cause a report to be filed on an unsafe condition. The report shall state the *occupancy* of the *structure* and the nature of the unsafe condition.

**109.4 Notice.** Whenever the *code official* determines that there has been a violation of this code or has grounds to believe that a violation has occurred, notice shall be given in the manner prescribed in Sections 109.4.1 and 109.4.2 to the *owner* or the *owner's* authorized agent, for the violation as specified in this code. Notices for *condemnation* procedures shall comply with this section.

**109.4.1 Form.** Such notice shall be in accordance with all of the following:

1. Be in writing.
2. Include a description of the real estate sufficient for identification.
3. Include a statement of the violation or violations and why the notice is being issued.
4. Include a correction order allowing a reasonable time to make the repairs and improvements required to bring the *dwelling unit* or *structure* into compliance with the provisions of this code.
5. Inform the property *owner* or *owner's* authorized agent of the right to appeal.
6. Include a statement of the right to file a lien in accordance with Section 107.3.

**109.4.2 Method of service.** Such notice shall be deemed to be properly served where a copy thereof is served in accordance with one of the following methods:

1. A copy is delivered personally.
2. A copy is sent by certified or registered mail addressed to the *owner* at the last known address with the return receipt requested.
3. A copy is delivered in any other manner as prescribed by local law.

If the certified or registered letter is returned showing that the letter was not delivered, a copy thereof shall be posted in a conspicuous place in or about the *structure* affected by such notice. Service of such notice in the foregoing manner upon the *owner's* agent or upon the *person* responsible for the *structure* shall constitute service of notice upon the *owner*.

**109.5 Unauthorized tampering.** Signs, tags or seals posted or affixed by the *code official* shall not be mutilated, destroyed or tampered with, or removed without authorization from the *code official*.

**109.6 Transfer of ownership.** It shall be unlawful for the *owner* of any *dwelling unit* or *structure* who has received a compliance order or upon whom a notice of violation has been served to sell, transfer, mortgage, lease or otherwise dispose of such *dwelling unit* or *structure* to another until the provisions of the compliance order or notice of violation have been complied with, or until such *owner* or the *owner's* authorized agent shall first furnish the grantee, transferee, mortgagee or lessee a true copy of any compliance order or notice of violation issued by the *code official* and shall furnish to the *code official* a signed and notarized statement from the grantee, transferee, mortgagee or lessee, acknowledging the receipt of such compliance order or notice of violation and fully accept-

ing the responsibility without condition for making the corrections or repairs required by such compliance order or notice of violation.

**109.7 Placarding.** Upon failure of the *owner*, *owner's* authorized agent or *person* responsible to comply with the notice provisions within the time given, the *code official* shall post on the *premises* or on defective equipment a placard bearing the word "Condemned" and a statement of the penalties provided for occupying the *premises*, operating the equipment or removing the placard. Such notice shall be posted in a conspicuous place in or about the *structure* affected by such notice. If the notice pertains to equipment, it shall be placed on the *condemned* equipment.

**109.7.1 Placard removal.** The *code official* shall remove the *condemnation* placard whenever the defect or defects upon which the *condemnation* and placarding action were based have been eliminated. Any *person* who defaces or removes a *condemnation* placard without the approval of the *code official* shall be subject to the penalties provided by this code.

**109.8 Prohibited occupancy.** Any occupied *structure condemned* and placarded by the *code official* shall be vacated as ordered by the *code official*. Any *person* who shall occupy a placarded *premises* or shall operate placarded equipment, and any *owner* or *owner's* authorized agent who shall let anyone occupy a placarded *premises* or operate placarded equipment shall be liable for the penalties provided by this code.

**109.9 Restoration or abatement.** The *structure* or equipment determined to be unsafe by the *code official* is permitted to be restored to a safe condition. The *owner*, *owner's* authorized agent, *operator* or *occupant* of a *structure*, *premises* or equipment deemed unsafe by the *code official* shall abate or cause to be abated or corrected such unsafe conditions either by repair, rehabilitation, demolition or other *approved* corrective action. To the extent that repairs, alterations, or additions are made or a change of *occupancy* occurs during the restoration of the *structure*, such repairs, alterations, additions, or change of *occupancy* shall comply with the requirements of the *International Existing Building Code*.

## 110—EMERGENCY MEASURES

**110.1 Imminent danger.** When, in the opinion of the *code official*, there is *imminent danger* of failure or collapse of a building or *structure* that endangers life, or when any *structure* or part of a *structure* has fallen and life is endangered by the occupation of the *structure*, or when there is actual or potential danger to the building *occupants* or those in the proximity of any *structure* because of explosives, explosive fumes or vapors or the presence of toxic fumes, gases or materials, or operation of defective or *dangerous* equipment, the *code official* is hereby authorized and empowered to order and require the *occupants* to vacate the *premises* forthwith. The *code official* shall cause to be posted at each entrance to such *structure* a notice reading as follows: "This Structure Is Unsafe and Its Occupancy Has Been Prohibited by the Code Official." It shall be unlawful for any *person* to enter such *structure* except for the purpose of securing the *structure*, making the required repairs, removing the hazardous condition or of demolishing the same.

**110.2 Temporary safeguards.** Notwithstanding other provisions of this code, whenever, in the opinion of the *code official*, there is *imminent danger* due to an unsafe condition, the *code official* shall order the necessary work to be done, including the boarding up of openings, to render such *structure* temporarily safe whether or not the legal procedure herein described has been instituted; and shall cause such other action to be taken as the *code official* deems necessary to meet such emergency.

**110.3 Closing streets.** When necessary for public safety, the *code official* shall temporarily close *structures* and close, or order the authority having jurisdiction to close, sidewalks, streets, *public ways* and places adjacent to unsafe structures, and prohibit the same from being utilized.

**110.4 Emergency repairs.** For the purposes of this section, the *code official* shall employ the necessary labor and materials to perform the required work as expeditiously as possible.

**110.5 Costs of emergency repairs.** Costs incurred in the performance of emergency work shall be paid by the jurisdiction. The legal counsel of the jurisdiction shall institute appropriate action against the *owner* of the *premises* or *owner's* authorized agent where the unsafe *structure* is or was located for the recovery of such costs.

**110.6 Hearing.** Any *person* ordered to take emergency measures shall comply with such order forthwith. Any affected *person* shall thereafter, upon petition directed to the appeals board, be afforded a hearing as described in this code.

## 111—DEMOLITION

**111.1 General.** When the code official determines any structure is so old, dilapidated or has become so out of repair and is dangerous, unsafe, insanitary and otherwise unfit for human habitation or occupancy the code official can order either of the following:

1. The code official is permitted to authorize the owner or owner's authorized agent to make the structure safe by repairs in order to make the structure safe and sanitary. Where there has been a cessation of construction repairs of any structure for a period of more than 2 years the structure will be ordered demolished and removed.
2. The code official is permitted to order the owner or owner's authorized agent to demolish and remove any such structure.

**111.2 Notices and orders.** Notices and orders shall comply with Section 109.4.

**111.3 Failure to comply.** If the *owner* of a *premises* or *owner's* authorized agent fails to comply with a demolition order within the time prescribed, the *code official* shall cause the *structure* to be demolished and removed, either through an available public agency



**SCOPE AND ADMINISTRATION**

or by contract or arrangement with private *persons*, and the *cost* of such demolition and removal shall be charged against the real estate upon which the *structure* is located and shall be a lien upon such real estate.

**111.4 Salvage materials.** Where any *structure* has been ordered demolished and removed, the governing body or other designated officer under said contract or arrangement aforesaid shall have the right to sell the salvage and valuable materials. The net proceeds of such sale, after deducting the expenses of such demolition and removal, shall be promptly remitted with a report of such sale or transaction, including the items of expense and the amounts deducted, for the *person* who is entitled thereto, subject to any order of a court. If such a surplus does not remain to be turned over, the report shall so state.

**User notes:****About this chapter:**

*Codes, by their very nature, are technical documents. Every word, term and punctuation mark can add to or change the meaning of a technical requirement. It is necessary to maintain a consensus on the specific meaning of each term contained in the code. Chapter 2 performs this function by stating clearly what specific terms mean for the purpose of the code.*

**SECTION 201—GENERAL**

**201.1 Scope.** Unless otherwise expressly stated, the following terms shall, for the purposes of this code, have the meanings shown in this chapter.

**201.2 Interchangeability.** Words stated in the present tense include the future; words stated in the masculine gender include the feminine and neuter; the singular number includes the plural and the plural, the singular.

**201.3 Terms defined in other codes.** Where terms are not defined in this code and are defined in the *International Building Code, International Existing Building Code, International Fire Code, International Fuel Gas Code, International Mechanical Code, International Plumbing Code, International Residential Code, International Zoning Code* or NFPA 70, such terms shall have the meanings ascribed to them as stated in those codes.

**201.4 Terms not defined.** Where terms are not defined through the methods authorized by this section, such terms shall have ordinarily accepted meanings such as the context implies.

**201.5 Parts.** Whenever the words “dwelling unit,” “dwelling,” “premises,” “building,” “rooming house,” “rooming unit,” “housekeeping unit” or “story” are stated in this code, they shall be construed as though they were followed by the words “or any part thereof.”

**SECTION 202—GENERAL DEFINITIONS**

**ANCHORED.** Secured in a manner that provides positive connection.

**[A] APPROVED.** Acceptable to the *code official*.

**[A] APPROVED AGENCY.** An established and recognized organization that is regularly engaged in conducting tests, furnishing inspection services or furnishing product evaluation or certification where such organization has been approved by the code official.

**BASEMENT.** That portion of a building that is partly or completely below grade.

**BATHROOM.** A room containing plumbing fixtures including a bathtub or shower.

**BEDROOM.** Any room or space used or intended to be used for sleeping purposes in either a dwelling or *sleeping unit*.

**[A] CODE OFFICIAL.** The official who is charged with the administration and enforcement of this code, or any duly authorized representative.

**CONDEMN.** To adjudge unfit for *occupancy*.

**COST OF SUCH DEMOLITION OR EMERGENCY REPAIRS.** The costs shall include the actual costs of the demolition or repair of the *structure* less revenues obtained if salvage was conducted prior to demolition or repair. Costs shall include, but not be limited to, expenses incurred or necessitated related to demolition or emergency repairs, such as asbestos survey and abatement if necessary; costs of inspectors, testing agencies or experts retained relative to the demolition or emergency repairs; costs of testing; surveys for other materials that are controlled or regulated from being dumped in a landfill; title searches; mailing(s); postings; recording; and attorney fees expended for recovering of the cost of emergency repairs or to obtain or enforce an order of demolition made by a *code official*, the governing body or board of appeals.

**[BS] DANGEROUS.** Any building, structure or portion thereof that meets any of the conditions described below shall be deemed dangerous:

1. The building or structure has collapsed, has partially collapsed, has moved off its foundation or lacks the necessary support of the ground.
2. There exists a significant risk of collapse, detachment or dislodgment of any portion, member, appurtenance or ornamentation of the building or structure under permanent, routine or frequent loads, or under snow, wind, rain, flood, earthquake or other environmental loads when such loads are imminent.

**DETACHED.** When a structural element is physically disconnected from another and that connection is necessary to provide a positive connection.

**DETERIORATION.** To weaken, disintegrate, corrode, rust or decay and lose effectiveness.

**[A] DWELLING UNIT.** A single unit providing complete, independent living facilities for one or more persons, including permanent provisions for living, sleeping, eating, cooking and sanitation.



## DEFINITIONS

**[Z] EASEMENT.** That portion of land or property reserved for present or future use by a *person* or agency other than the legal fee owner(s) of the property. The *easement* shall be permitted to be for use under, on or above said lot or lots.

**EMERGENCY ESCAPE AND RESCUE OPENING.** An operable exterior window, door or other similar device that provides for a means of escape and access for rescue in the event of an emergency.

**EQUIPMENT SUPPORT.** Those structural members or assemblies of members or manufactured elements, including braces, frames, lugs, snuggers, hangers or saddles, that transmit gravity load, lateral load and operating load between the equipment and the structure.

**EXTERIOR PROPERTY.** The open space on the *premises* and on adjoining property under the control of *owners* or *operators* of such *premises*.

**GARBAGE.** The animal or vegetable waste resulting from the handling, preparation, cooking and consumption of food.

**[BE] GUARD.** A building component or a system of building components located at or near the open sides of elevated walking surfaces that minimizes the possibility of a fall from the walking surface to a lower level.

**[BG] HABITABLE SPACE.** Space in a *structure* for living, sleeping, eating or cooking. *Bathrooms, toilet rooms, closets, halls, storage or utility spaces, and similar areas* are not considered *habitable spaces*.

**[A] HISTORIC BUILDING.** Any building or *structure* that is one or more of the following:

1. Listed or certified as eligible for listing, by the State Historic Preservation Officer or the Keeper of the National Register of Historic Places, in the National Register of Historic Places.
2. Designated as *historic* under an applicable state or local law.
3. Certified as a contributing resource within a National Register or state or locally designated *historic* district.

**HOUSEKEEPING UNIT.** A room or group of rooms forming a single *habitable space* equipped and intended to be used for living, sleeping, cooking and eating that does not contain, within such a unit, a toilet, lavatory and bathtub or shower.

**IMMINENT DANGER.** A condition that could cause serious or life-threatening injury or death at any time.

**INFESTATION.** The presence, within or contiguous to, a *structure* or *premises* of insects, rodents, vermin or other pests.

**INOPERABLE MOTOR VEHICLE.** A vehicle that cannot be driven upon the public streets for reason including but not limited to being unlicensed, wrecked, abandoned, in a state of disrepair, or incapable of being moved under its own power.

**[A] LABELED.** Equipment, materials or products to which have been affixed a label, seal, symbol or other identifying mark of a nationally recognized testing laboratory, *approved* agency or other organization concerned with product evaluation that maintains periodic inspection of the production of the above-*labeled* items and whose labeling indicates either that the equipment, material or product meets identified standards or has been tested and found suitable for a specified purpose.

**LET FOR OCCUPANCY or LET.** To permit, provide or offer possession or *occupancy* of a dwelling, *dwelling unit, rooming unit, building, premise* or *structure* by a *person* who is or is not the legal *owner* of record thereof, pursuant to a written or unwritten lease, agreement or license, or pursuant to a recorded or unrecorded agreement of contract for the sale of land.

**NEGLECT.** The lack of proper maintenance for a building or *structure*.

**[A] OCCUPANCY.** The purpose for which a building or portion thereof is utilized or occupied.

**OCCUPANT.** Any individual living or sleeping in a building, or having possession of a space within a building.

**OPENABLE AREA.** That part of a window, skylight or door which is available for unobstructed *ventilation* and which opens directly to the outdoors.

**OPERATOR.** Any *person* who has charge, care or control of a *structure* or *premises* that is *let* or offered for *occupancy*.

**[A] OWNER.** Any *person, agent, operator, firm* or corporation having legal or equitable interest in the property; or recorded in the official records of the state, county or municipality as holding title to the property; or otherwise having control of the property, including the guardian of the estate of any such *person*, and the executor or administrator of the estate of such *person* if ordered to take possession of real property by a court.

**[A] PEER REVIEW.** An independent and objective technical review conducted by an approved third party.

**[A] PERSON.** An individual, corporation, partnership or any other group acting as a unit.

**PEST ELIMINATION.** The control and elimination of insects, rodents or other pests by eliminating their harborage places; by removing or making inaccessible materials that serve as their food or water; by other *approved pest elimination* methods.

**[SP] POWER SAFETY COVER.** A pool cover that is placed over the water area and is opened and closed with a motorized mechanism activated by a control switch.

**[A] PREMISES.** A lot, plot or parcel of land, *easement* or *public way*, including any *structures* thereon.

**[A] PUBLIC WAY.** Any street, alley or other parcel of land that: is open to the outside air; leads to a street; has been deeded, dedicated or otherwise permanently appropriated to the public for public use; and has a clear width and height of not less than 10 feet (3048 mm).

**ROOMING HOUSE.** A building arranged or occupied for lodging, with or without meals, for compensation and not occupied as a one- or two-family dwelling.

**ROOMING UNIT.** Any room or group of rooms forming a single habitable unit occupied or intended to be occupied for sleeping or living, but not for cooking purposes.

**RUBBISH.** Combustible and noncombustible waste materials, except *garbage*; the term shall include the residue from the burning of wood, coal, coke and other combustible materials, paper, rags, cartons, boxes, wood, excelsior, rubber, leather, tree branches, *yard* trimmings, tin cans, metals, mineral matter, glass, crockery and dust and other similar materials.

**[SP] SAFETY COVER.** A structure, fabric or assembly, along with attendant appurtenances and anchoring mechanisms, that is temporarily placed or installed over an entire pool, spa or hot tub and secured in place after all bathers are absent from the water.

**[A] SLEEPING UNIT.** A room or space in which people sleep, which can also include permanent provisions for living, eating and either sanitation or kitchen facilities, but not both. Such rooms and spaces that are also part of a *dwelling unit* are not *sleeping units*.

**[BS] STORM SHELTER.** A building, structure or portion thereof, constructed in accordance with ICC 500, designated for use during hurricanes, tornadoes or other severe windstorms.

**STRICT LIABILITY OFFENSE.** An offense in which the prosecution in a legal proceeding is not required to prove criminal intent as a part of its case. It is enough to prove that the defendant either did an act which was prohibited, or failed to do an act which the defendant was legally required to do.

**[A] STRUCTURE.** That which is built or constructed.

**TENANT.** A *person*, corporation, partnership or group, whether or not the legal *owner* of record, occupying a building or portion thereof as a unit.

**TOILET ROOM.** A room containing a water closet or urinal but not a bathtub or shower.

**ULTIMATE DEFORMATION.** The deformation at which failure occurs and that shall be deemed to occur if the sustainable load reduces to 80 percent or less of the maximum strength.

**[M] VENTILATION.** The natural or mechanical process of supplying conditioned or unconditioned air to, or removing such air from, any space.

**WORKMANLIKE.** Executed in a skilled manner; e.g., generally plumb, level, square, in line, undamaged and without marring adjacent work.

**[Z] YARD.** An open space on the same lot with a *structure*.

## GENERAL REQUIREMENTS

## User notes:

**About this chapter:**

Chapter 3 is broad in scope and includes a variety of requirements for the maintenance of exterior property areas, as well as the interior and exterior elements of the structure, that are intended to maintain a minimum level of safety and sanitation for both the general public and the occupants of a structure, and to maintain a building's structural and weather-resistance performance. Specifically, Chapter 3 contains criteria for the maintenance of building components; vacant structures and land; the safety, sanitation and appearance of the interior and exterior of structures and all exterior property areas; accessory structures; extermination of insects and rodents; access barriers to swimming pools, spas and hot tubs; vehicle storage and owner/occupant responsibilities.

## SECTION 301—GENERAL



**301.1 Scope.** The provisions of this chapter shall govern the minimum conditions and the responsibilities of persons for maintenance of structures, equipment and exterior property.

**301.2 Responsibility.** The owner of the premises shall maintain the structures and exterior property in compliance with these requirements and the code under which the building was constructed, except as otherwise provided for in this code. The owner or owner's agent shall be responsible to ensure that any repairs, additions or alterations to the building or portion thereof are performed or constructed in accordance with the *International Building Code*, *International Residential Code* or *International Existing Building Code*. A person shall not occupy as owner-occupant or permit another person to occupy premises that are not in a sanitary and safe condition and that do not comply with the requirements of this chapter. Occupants of a dwelling unit, rooming unit or housekeeping unit are responsible for keeping in a clean, sanitary and safe condition that part of the dwelling unit, rooming unit, housekeeping unit or premises they occupy and control.

**301.3 Vacant structures and land.** Vacant structures and premises thereof or vacant land shall be maintained in a clean, safe, secure and sanitary condition as provided herein so as not to cause a blighting problem or adversely affect the public health or safety.

## SECTION 302—EXTERIOR PROPERTY AREAS

**302.1 Sanitation.** Exterior property and premises shall be maintained in a clean, safe and sanitary condition. The occupant shall keep that part of the exterior property that such occupant occupies or controls in a clean and sanitary condition.

**302.2 Grading and drainage.** Premises shall be graded and maintained to prevent the erosion of soil and to prevent the accumulation of stagnant water thereon, or within any structure located thereon.

**Exception:** Approved retention areas and reservoirs.

**302.3 Sidewalks and driveways.** Sidewalks, walkways, stairs, driveways, parking spaces and similar areas shall be kept in a proper state of repair, and maintained free from hazardous conditions.

**302.4 Weeds.** Premises and exterior property shall be maintained free from weeds or plant growth in excess of [JURISDICTION TO INSERT HEIGHT IN INCHES]. Noxious weeds shall be prohibited. Weeds shall be defined as all grasses, annual plants and vegetation, other than trees or shrubs provided; however, this term shall not include cultivated flowers and gardens.

Upon failure of the owner or agent having charge of a property to cut and destroy weeds after service of a notice of violation, they shall be subject to prosecution in accordance with Section 107.3 and as prescribed by the authority having jurisdiction. Upon failure to comply with the notice of violation, any duly authorized employee of the jurisdiction or contractor hired by the jurisdiction shall be authorized to enter upon the property in violation and cut and destroy the weeds growing thereon, and the costs of such removal shall be paid by the owner or agent responsible for the property.

**302.5 Rodent harborage.** Structures and exterior property shall be kept free from rodent harborage and infestation. Where rodents are found, they shall be promptly exterminated by approved processes that will not be injurious to human health. After pest elimination, proper precautions shall be taken to eliminate rodent harborage and prevent reinfestation.

**302.6 Exhaust vents.** Pipes, ducts, conductors, fans or blowers shall not discharge gases, steam, vapor, hot air, grease, smoke, odors or other gaseous or particulate wastes directly on abutting or adjacent public or private property or that of another tenant.

**302.7 Accessory structures.** Accessory structures, including detached garages, fences and walls, shall be maintained structurally sound and in good repair.

**302.8 Motor vehicles.** Except as provided for in other regulations, inoperative or unlicensed motor vehicles shall not be parked, kept or stored on any premises, and vehicles shall not at any time be in a state of major disassembly, disrepair, or in the process of being stripped or dismantled. Painting of vehicles is prohibited unless conducted inside an approved spray booth.

**Exception:** A vehicle of any type is permitted to undergo major overhaul, including body work, provided that such work is performed inside a structure or similarly enclosed area designed and approved for such purposes.

**302.9 Defacement of property.** A person shall not willfully or wantonly damage, mutilate or deface any exterior surface of any *structure* or building on any private or public property by placing thereon any marking, carving or graffiti.

It shall be the responsibility of the *owner* to restore said surface to an *approved* state of maintenance and repair.

### SECTION 303—SWIMMING POOLS, SPAS AND HOT TUBS

**303.1 Swimming pools.** Swimming pools shall be maintained in a clean and sanitary condition, and in good repair.

**303.2 Enclosures.** Private swimming pools, hot tubs and spas, containing water more than 24 inches (610 mm) in depth shall be completely surrounded by a fence or barrier not less than 48 inches (1219 mm) in height above the finished ground level measured on the side of the barrier away from the pool. Gates and doors in such barriers shall be self-closing and self-latching. Where the self-latching device is less than 54 inches (1372 mm) above the bottom of the gate, the release mechanism shall be located on the pool side of the gate. Self-closing and self-latching gates shall be maintained such that the gate will positively close and latch when released from an open position of 6 inches (152 mm) from the gatepost. An existing pool enclosure shall not be removed, replaced or changed in a manner that reduces its effectiveness as a safety barrier.

#### Exceptions:

1. Spas or hot tubs equipped with a lockable safety cover that complies with ASTM F1346.
2. Private swimming pools equipped with a power safety cover that complies with ASTM F1346 and is in working condition using the control switch.



### SECTION 304—EXTERIOR STRUCTURE

**304.1 General.** The exterior of a *structure* shall be maintained in good repair, structurally sound and sanitary so as not to pose a threat to the public health, safety or welfare.

**304.1.1 Potentially unsafe conditions.** The following conditions shall be considered to be potentially unsafe, shall be assessed and shall be addressed in compliance with the *International Existing Building Code*, the *International Residential Code* or the *International Building Code*:

1. Structural members have *deterioration* or distress that appears to reduce their load-carrying capacity.
2. The *anchorage* of the floor or roof to walls or columns, and of walls and columns to foundations has *deterioration* or distress that appears to reduce its load-carrying capacity.
3. *Structures* or components thereof have *deterioration* or distress that appears to reduce their load-carrying capacity.
4. Siding and masonry joints including joints between the building envelope and the perimeter of windows, doors and skylights are not maintained, weather resistant or watertight.
5. Foundation systems that are not firmly supported by footings, are not plumb and free from open cracks and breaks, are not properly *anchored* or are not capable of supporting all nominal loads and resisting all load effects.
6. Exterior walls that are not *anchored* to supporting and supported elements or are not plumb and free of holes, cracks or breaks and loose or rotting materials, are not properly *anchored* or are not capable of supporting all nominal loads and resisting all load effects.
7. Roofing or roofing components that have defects that admit rain, roof surfaces with inadequate drainage, or any portion of the roof framing that is not in good repair with signs of *deterioration*, fatigue or without proper *anchorage* and incapable of supporting all nominal loads and resisting all load effects.
8. Flooring and flooring components with defects that affect serviceability or flooring components that show signs of *deterioration* or fatigue, are not properly *anchored* or are incapable of supporting all nominal loads and resisting all load effects.
9. Veneer, cornices, belt courses, corbels, trim, wall facings and similar decorative features not properly *anchored* or that are *anchored* with connections not capable of supporting all nominal loads and resisting all load effects.
10. Overhang extensions or projections including, but not limited to, trash chutes, canopies, marquees, signs, awnings, fire escapes, standpipes and exhaust ducts not properly *anchored* or that are *anchored* with connections not capable of supporting all nominal loads and resisting all load effects.
11. Exterior stairs, decks, porches, balconies and all similar appurtenances attached thereto, including *guards* and handrails, are not structurally sound, not properly *anchored* or that are *anchored* with connections not capable of supporting all nominal loads and resisting all load effects.
12. Chimneys, cooling towers, smokestacks and similar appurtenances not structurally sound or not properly *anchored*, or that are *anchored* with connections not capable of supporting all nominal loads and resisting all load effects.

#### Exceptions:

1. Where substantiated otherwise by an *approved* method.
2. Demolition of unsafe conditions shall be permitted where *approved* by the *code official*.



## GENERAL REQUIREMENTS

**304.2 Protective treatment.** Exterior surfaces, including but not limited to, doors, door and window frames, cornices, porches, trim, balconies, decks and fences, shall be maintained in good condition. Exterior wood surfaces, other than decay-resistant woods, shall be protected from the elements and decay by painting or other protective covering or treatment. Peeling, flaking and chipped paint shall be eliminated and surfaces repainted. Siding and masonry joints, as well as those between the building envelope and the perimeter of windows, doors and skylights, shall be maintained weather resistant and water tight. Metal surfaces subject to rust or corrosion shall be coated to inhibit such rust and corrosion, and surfaces with rust or corrosion shall be stabilized and coated to inhibit future rust and corrosion. Oxidation stains shall be removed from exterior surfaces. Surfaces designed for stabilization by oxidation are exempt from this requirement.

**[F] 304.3 Premises identification.** Buildings shall have *approved* address numbers placed in a position to be plainly legible and visible from the street or road fronting the property. These numbers shall contrast with their background. Address numbers shall be Arabic numerals or alphabet letters. Numbers shall be not less than 4 inches (102 mm) in height with a minimum stroke width of 0.5 inch (12.7 mm).

**304.4 Structural members.** Structural members shall be maintained free from *deterioration*, and shall be capable of safely supporting the imposed dead and live loads.

**304.5 Foundation walls.** Foundation walls shall be maintained plumb and free from open cracks and breaks and shall be kept in such condition so as to prevent the entry of rodents and other pests.

**304.6 Exterior walls.** Exterior walls shall be free from holes, breaks, and loose or rotting materials; and maintained weatherproof and properly surface coated where required to prevent *deterioration*.

**304.7 Roofs and drainage.** The roof and flashing shall be sound, tight and not have defects that admit rain. Roof drainage shall be adequate to prevent dampness or *deterioration* in the walls or interior portion of the *structure*. Roof drains, gutters and downspouts shall be maintained in good repair and free from obstructions. Roof water shall not be discharged in a manner that creates a public nuisance.

**304.8 Decorative features.** Cornices, belt courses, corbels, terra cotta trim, wall facings and similar decorative features shall be maintained in good repair with proper *anchorage* and in a safe condition.

**304.9 Overhang extensions.** Overhang extensions including, but not limited to, canopies, marquees, signs, metal awnings, fire escapes, standpipes and exhaust ducts shall be maintained in good repair and be properly *anchored* so as to be kept in a sound condition. Where required, all exposed surfaces of metal or wood shall be protected from the elements and against decay or rust by periodic application of weather-coating materials, such as paint or similar surface treatment.

**304.10 Stairways, decks, porches and balconies.** Every exterior stairway, deck, porch and balcony, and all appurtenances attached thereto, shall be maintained structurally sound, in good repair, with proper *anchorage* and capable of supporting the imposed loads.

**304.11 Chimneys and towers.** Chimneys, cooling towers, smoke stacks, and similar appurtenances shall be maintained structurally safe and sound, and in good repair. Exposed surfaces of metal or wood shall be protected from the elements and against decay or rust by periodic application of weather-coating materials, such as paint or similar surface treatment.

**304.12 Handrails and guards.** Every handrail and *guard* shall be firmly fastened and capable of supporting normally imposed loads and shall be maintained in good condition.

**304.13 Window, skylight and door frames.** Every window, skylight, door and frame shall be kept in sound condition, good repair and weathertight.

**304.13.1 Glazing.** Glazing materials shall be maintained free from cracks and holes.

**304.13.2 Openable windows.** Every window, other than a fixed window, shall be easily openable and capable of being held in position by window hardware.

**304.14 Insect screens.** During the period from [DATE] to [DATE], every door, window and other outside opening required for *ventilation* of habitable rooms, food preparation areas, food service areas or any areas where products to be included or utilized in food for human consumption are processed, manufactured, packaged or stored shall be supplied with *approved* tightly fitting screens of minimum 16 mesh per inch (16 mesh per 25 mm), and every screen door used for insect control shall have a self-closing device in good working condition.

**Exception:** Screens shall not be required where other *approved* means, such as air curtains or insect repellent fans, are employed.

**304.15 Doors.** Exterior doors, door assemblies, operator systems if provided, and hardware shall be maintained in good condition. Locks at all entrances to *dwelling units* and *sleeping units* shall tightly secure the door. Locks on means of egress doors shall be in accordance with Section 702.3.

**304.16 Basement hatchways.** Every *basement* hatchway shall be maintained to prevent the entrance of rodents, rain and surface drainage water.

**304.17 Guards for basement windows.** Every *basement* window that is openable shall be supplied with rodent shields, storm windows or other *approved* protection against the entry of rodents.

**304.18 Building security.** Doors, windows or hatchways for *dwelling units*, room units or *housekeeping units* shall be provided with devices designed to provide security for the *occupants* and property within.

**304.18.1 Doors.** Doors providing access to an individual *dwelling unit, rooming unit or housekeeping unit* that is rented, leased or *let* where equipped with a deadbolt lock, the deadbolt shall be designed to be readily openable from the side from which egress is to be made without the need for keys, special knowledge or effort and shall have a minimum lock throw of 1 inch (25 mm). Such deadbolt locks shall be installed according to the manufacturer's specifications and maintained in good working order. For the purpose of this section, a sliding bolt shall not be considered an acceptable deadbolt lock.

**304.18.2 Windows.** Operable windows located in whole or in part within 6 feet (1828 mm) above ground level or a walking surface below that provide access to a *dwelling unit, rooming unit or housekeeping unit* that is rented, leased or *let* shall be equipped with a window sash locking device.

**304.18.3 Basement hatchways.** *Basement* hatchways that provide access to a *dwelling unit, rooming unit or housekeeping unit* that is rented, leased or *let* shall be equipped with devices that secure the units from unauthorized entry.

**304.19 Gates.** Exterior gates, gate assemblies, operator systems if provided, and hardware shall be maintained in good condition. Latches at all entrances shall tightly secure the gates.

## SECTION 305—INTERIOR STRUCTURE

**305.1 General.** The interior of a *structure* and equipment therein shall be maintained in good repair, structurally sound and in a sanitary condition. *Occupants* shall keep that part of the *structure* that they occupy or control in a clean and sanitary condition. Every *owner* of a *structure* containing a *rooming house, housekeeping units, a hotel, a dormitory, two or more dwelling units or two or more nonresidential occupancies*, shall maintain, in a clean and sanitary condition, the shared or public areas of the *structure* and *exterior property*.

**305.1.1 Potentially unsafe conditions.** The following conditions shall be considered to be potentially unsafe, shall be assessed and shall be addressed in compliance with the *International Existing Building Code, the International Residential Code or the International Building Code*:

1. Structural members have *deterioration* or distress that appears to reduce their load-carrying capacity.
2. The *anchorage* of the floor or roof to walls or columns, and of walls and columns to foundations has *deterioration* or distress that appears to reduce its load-carrying capacity.
3. *Structures* or components thereof have *deterioration* or distress that appears to reduce their load-carrying capacity.
4. Stairs, landings, balconies and all similar walking surfaces, including *guards* and handrails, are not structurally sound, not properly *anchored* or are *anchored* with connections not capable of supporting all nominal loads and resisting all load effects.
5. Foundation systems that are not firmly supported by footings are not plumb and free from open cracks and breaks, are not properly *anchored* or are not capable of supporting all nominal loads and resisting all load effects.

### Exceptions:

1. Where substantiated otherwise by an *approved* method.
2. Demolition of unsafe conditions shall be permitted where *approved* by the *code official*.

**305.2 Structural members.** Structural members shall be maintained structurally sound, and be capable of supporting the imposed loads.

**305.3 Interior surfaces.** Interior surfaces, including windows and doors, shall be maintained in good, clean and sanitary condition. Peeling, chipping, flaking or abraded paint shall be repaired, removed or covered. Cracked or loose plaster, decayed wood and other defective surface conditions shall be corrected.

**305.4 Stairs and walking surfaces.** Every stair, ramp, landing, balcony, porch, deck or other walking surface shall be maintained in sound condition and good repair.

**305.5 Handrails and guards.** Every handrail and *guard* shall be firmly fastened and capable of supporting normally imposed loads and shall be maintained in good condition.

**305.6 Interior doors.** Every interior door shall fit reasonably well within its frame and shall be capable of being opened and closed by being properly and securely attached to jambs, headers or tracks as intended by the manufacturer of the attachment hardware.

## SECTION 306—COMPONENT SERVICEABILITY

**306.1 General.** The components of a *structure* and equipment therein shall be maintained in good repair, structurally sound and in a sanitary condition.

**306.1.1 Potentially unsafe conditions.** Where any of the following conditions cause the component or system to be beyond its limit state, the component or system shall be considered to be unsafe and shall be addressed in compliance with the *International Existing Building Code, the International Residential Code or the International Building Code*:

1. Soils that have been subjected to any of the following conditions:
  - 1.1. Collapse of footing or foundation system.
  - 1.2. Damage to footing, foundation, concrete or other structural element due to soil expansion.



## GENERAL REQUIREMENTS

- 1.3. Adverse effects to the design strength of footing, foundation, concrete or other structural element due to a chemical reaction from the soil.
- 1.4. Inadequate soil as determined by a geotechnical investigation.
- 1.5. Where the allowable bearing capacity of the soil is in doubt.
- 1.6. Adverse effects to the footing, foundation, concrete or other structural element due to the ground water table.
2. Concrete that has been subjected to any of the following conditions:
  - 2.1. *Deterioration.*
  - 2.2. *Ultimate deformation.*
  - 2.3. Fractures.
  - 2.4. Fissures.
  - 2.5. Spalling.
  - 2.6. Exposed reinforcement.
  - 2.7. *Detached, dislodged or failing connections.*
3. Aluminum that has been subjected to any of the following conditions:
  - 3.1. *Deterioration.*
  - 3.2. Corrosion.
  - 3.3. Elastic deformation.
  - 3.4. *Ultimate deformation.*
  - 3.5. Stress or strain cracks.
  - 3.6. Joint fatigue.
  - 3.7. *Detached, dislodged or failing connections.*
4. Masonry that has been subjected to any of the following conditions:
  - 4.1. *Deterioration.*
  - 4.2. *Ultimate deformation.*
  - 4.3. Fractures in masonry or mortar joints.
  - 4.4. Fissures in masonry or mortar joints.
  - 4.5. Spalling.
  - 4.6. Exposed reinforcement.
  - 4.7. *Detached, dislodged or failing connections.*
5. Steel that has been subjected to any of the following conditions:
  - 5.1. *Deterioration.*
  - 5.2. Elastic deformation.
  - 5.3. *Ultimate deformation.*
  - 5.4. Metal fatigue.
  - 5.5. *Detached, dislodged or failing connections.*
6. Wood that has been subjected to any of the following conditions:
  - 6.1. Ultimate deformation.
  - 6.2. Deterioration.
  - 6.3. Damage from insects, rodents and other vermin.
  - 6.4. Fire damage beyond charring.
  - 6.5. Significant splits and checks.
  - 6.6. Horizontal shear cracks.
  - 6.7. Vertical shear cracks.
  - 6.8. Inadequate support.
  - 6.9. *Detached, dislodged or failing connections.*
  - 6.10. Excessive cutting and notching.

**Exceptions:**

1. Where substantiated otherwise by an *approved* method.
2. Demolition of unsafe conditions shall be permitted where *approved* by the *code official*.

**SECTION 307—HANDRAILS AND GUARDRAILS**

**307.1 Handrails.** Stairs having more than four risers shall have a handrail on one side of the stair.

**307.1.1 Height.** Handrails shall be not less than 30 inches (762 mm) in height or more than 42 inches (1067 mm) in height measured vertically above the nosing of the tread or above the finished floor of the landing or walking surfaces.

**307.2 Guards.** Guards shall be provided along open-sided walking surfaces, including balconies, porches, decks, stairs, ramps and landings, that are more than 30 inches (762 mm) above the floor or grade below.

**Exception:** Guards shall not be required where exempted by the adopted building code.

**307.2.1 Height.** Guards shall be not less than 30 inches (762 mm) high.

**SECTION 308—RUBBISH AND GARBAGE**

**308.1 Accumulation of rubbish or garbage.** Exterior property and premises, and the interior of every structure, shall be free from any accumulation of rubbish or garbage.

**308.2 Disposal of rubbish.** Every occupant of a structure shall dispose of all rubbish in a clean and sanitary manner by placing such rubbish in approved containers.

**308.2.1 Rubbish storage facilities.** The owner of every occupied premises shall supply approved covered containers for rubbish, and the owner of the premises shall be responsible for the removal of rubbish.

**308.2.2 Refrigerators.** Refrigerators and similar equipment not in operation shall not be discarded, abandoned or stored on premises without first removing the doors.

**308.3 Disposal of garbage.** Every occupant of a structure shall dispose of garbage in a clean and sanitary manner by placing such garbage in an approved garbage disposal facility or approved garbage containers.

**308.3.1 Garbage facilities.** The owner of every dwelling shall supply one of the following: an approved mechanical food waste grinder in each dwelling unit; an approved incinerator unit in the structure available to the occupants in each dwelling unit; or an approved leakproof, covered, outside garbage container.

**308.3.2 Containers.** The operator of every establishment producing garbage shall provide, and at all times cause to be utilized, approved leakproof containers provided with close-fitting covers for the storage of such materials until removed from the premises for disposal.

**SECTION 309—PEST ELIMINATION**

**309.1 Infestation.** Structures shall be kept free from insect and rodent infestation. Structures in which insects or rodents are found shall be promptly exterminated by approved processes that will not be injurious to human health. After pest elimination, proper precautions shall be taken to prevent reinfestation.

**309.2 Owner.** The owner of any structure shall be responsible for pest elimination within the structure prior to renting or leasing the structure.

**309.3 Single occupant.** The occupant of a one-family dwelling or of a single-tenant nonresidential structure shall be responsible for pest elimination on the premises.

**309.4 Multiple occupancy.** The owner of a structure containing two or more dwelling units, a multiple occupancy, a rooming house or a nonresidential structure shall be responsible for pest elimination in the public or shared areas of the structure and exterior property. If infestation is caused by failure of an occupant to prevent such infestation in the area occupied, the occupant and owner shall be responsible for pest elimination.

**309.5 Occupant.** The occupant of any structure shall be responsible for the continued rodent and pest-free condition of the structure.

**Exception:** Where the infestations are caused by defects in the structure, the owner shall be responsible for pest elimination.

**SECTION 310—ACCESSIBILITY**

**310.1 General.** A facility that is required to be accessible shall be maintained accessible during occupancy.

**310.1.1 Maintenance.** The accessible features of a facility shall be maintained in good repair, in a clean, structurally sound and sanitary condition, and free from impediments to accessibility.

**SECTION 311—STORM SHELTERS**

**311.1 General.** Community storm shelters shall be evaluated, maintained and repaired in accordance with this section and ICC 500.

**311.2 Evaluation.** Community storm shelters shall be evaluated annually and when requested by the authority having jurisdiction in accordance with ICC 500.

**311.3 Maintenance and repairs.** Community storm shelters shall be maintained in an operable condition. All structural and operational elements shall be repaired or replaced in accordance with ICC 500 where damaged or found to be inoperable.



## LIGHT, VENTILATION AND OCCUPANCY LIMITATIONS

### User notes:

#### About this chapter:

Chapter 4 sets forth requirements to establish the minimum environment for occupiable and habitable buildings by establishing the minimum criteria for light and ventilation and identifying occupancy limitations including minimum room width and area, minimum ceiling height and restrictions to prevent overcrowding.

### SECTION 401—GENERAL

**401.1 Scope.** The provisions of this chapter shall govern the minimum conditions and standards for light, *ventilation* and space for occupying a *structure*.

**401.2 Responsibility.** The *owner* of the *structure* shall provide and maintain light, *ventilation* and space conditions in compliance with these requirements. A *person* shall not occupy as *owner-occupant*, or permit another *person* to occupy, any *premises* that do not comply with the requirements of this chapter.

**401.3 Alternative devices.** In lieu of the means for natural light and *ventilation* herein prescribed, artificial light or mechanical *ventilation* complying with the *International Building Code* shall be permitted.

### SECTION 402—LIGHT

**402.1 Habitable spaces.** Every *habitable space* shall have not less than one window of *approved* size facing directly to the outdoors or to a court. The minimum total glazed area for every *habitable space* shall be 8 percent of the floor area of such room. Wherever walls or other portions of a *structure* face a window of any room and such obstructions are located less than 3 feet (914 mm) from the window and extend to a level above that of the ceiling of the room, such window shall not be deemed to face directly to the outdoors nor to a court and shall not be included as contributing to the required minimum total window area for the room.

**Exception:** Where natural light for rooms or spaces without exterior glazing areas is provided through an adjoining room, the unobstructed opening to the adjoining room shall be not less than 8 percent of the floor area of the interior room or space, or not less than 25 square feet (2.33 m<sup>2</sup>), whichever is greater. The exterior glazing area shall be based on the total floor area being served.

**402.2 Common halls and stairways.** Every common hall and stairway in residential *occupancies*, other than in one-and two-family dwellings, shall be lighted at all times with not less than a 60-watt standard incandescent light bulb for each 200 square feet (19 m<sup>2</sup>) of floor area or equivalent illumination, provided that the spacing between lights shall not be greater than 30 feet (9144 mm). In other than residential *occupancies*, interior and exterior means of egress, stairways shall be illuminated at all times the building space served by the means of egress is occupied with not less than 1 footcandle (11 lux) at floors, landings and treads.

**402.3 Other spaces.** Other spaces shall be provided with natural or artificial light sufficient to permit the maintenance of sanitary conditions, and the safe *occupancy* of the space and utilization of the appliances, equipment and fixtures.

### SECTION 403—VENTILATION

**403.1 Habitable spaces.** Every *habitable space* shall have not less than one openable window. The total *openable area* of the window in every room shall be equal to not less than 45 percent of the minimum glazed area required in Section 402.1.

**Exception:** Where rooms and spaces without openings to the outdoors are ventilated through an adjoining room, the unobstructed opening to the adjoining room shall be not less than 8 percent of the floor area of the interior room or space, but not less than 25 square feet (2.33 m<sup>2</sup>). The *ventilation* openings to the outdoors shall be based on a total floor area being ventilated.

**403.2 Bathrooms and toilet rooms.** Every *bathroom* and *toilet room* shall comply with the *ventilation* requirements for *habitable spaces* as required by Section 403.1, except that a window shall not be required in such spaces equipped with a mechanical *ventilation* system. Air exhausted by a mechanical *ventilation* system from a *bathroom* or *toilet room* shall discharge to the outdoors and shall not be recirculated.

**403.3 Cooking facilities.** Unless *approved* through the certificate of *occupancy*, cooking shall not be permitted in any *rooming unit* or dormitory unit, and a cooking facility or appliance shall not be permitted to be present in the *rooming unit* or dormitory unit.

#### Exceptions:

1. Where specifically *approved* in writing by the *code official*.
2. Devices such as coffee pots and microwave ovens shall not be considered cooking appliances.

**403.4 Process ventilation.** Where injurious, toxic, irritating or noxious fumes, gases, dusts or mists are generated, a local exhaust *ventilation* system shall be provided to remove the contaminating agent at the source. Air shall be exhausted to the exterior and not be recirculated to any space.

**403.5 Clothes dryer exhaust.** Clothes dryer exhaust systems shall be independent of all other systems and shall be exhausted outside the *structure* in accordance with the manufacturer's instructions.

**Exception:** Listed and *labeled* condensing (ductless) clothes dryers.

#### SECTION 404—OCCUPANCY LIMITATIONS

**404.1 Privacy.** *Dwelling units*, hotel units, *housekeeping units*, *rooming units* and dormitory units shall be arranged to provide privacy and be separate from other adjoining spaces.

**404.2 Minimum room widths.** A habitable room, other than a kitchen, shall be not less than 7 feet (2134 mm) in any plan dimension. Kitchens shall have a minimum clear passageway of 3 feet (914 mm) between counterfronts and appliances or counterfronts and walls.

**404.3 Minimum ceiling heights.** *Habitable spaces*, hallways, corridors, laundry areas, *bathrooms*, *toilet rooms* and habitable *basement* areas shall have a minimum clear ceiling height of 7 feet (2134 mm).

**Exceptions:**

1. In one- and two-family dwellings, beams or girders spaced not less than 4 feet (1219 mm) on center and projecting not greater than 6 inches (152 mm) below the required ceiling height.
2. *Basement* rooms in one- and two-family dwellings occupied exclusively for laundry, study or recreation purposes, having a minimum ceiling height of 6 feet 8 inches (2033 mm) with a minimum clear height of 6 feet 4 inches (1932 mm) under beams, girders, ducts and similar obstructions.
3. In one- and two-family dwellings, rooms occupied exclusively for *bathrooms*, *toilet rooms* and laundry rooms having a minimum ceiling height of 6 feet 8 inches (2033 mm).
4. Rooms occupied exclusively for sleeping, study or similar purposes and having a sloped ceiling over all or part of the room, with a minimum clear ceiling height of 7 feet (2134 mm) over not less than one-third of the required minimum floor area. In calculating the floor area of such rooms, only those portions of the floor area with a minimum clear ceiling height of 5 feet (1524 mm) shall be included.

**404.4 Habitable room requirements.** Every habitable room shall comply with the requirements of Sections 404.4.1 through 404.4.5.

**404.4.1 Room area.** Every habitable room shall contain not less than 70 square feet (6.5 m<sup>2</sup>) and every bedroom occupied by more than one *person* shall contain not less than 50 square feet (4.6 m<sup>2</sup>) of floor area for each *occupant* thereof.

**404.4.2 Access from bedrooms.** *Bedrooms* shall not constitute the only means of access to other *bedrooms* or *habitable spaces* and shall not serve as the only means of egress from other *habitable spaces*.

**Exception:** Units that contain fewer than two *bedrooms*.

**404.4.3 Water closet accessibility.** Every *bedroom* shall have access to not less than one water closet and one lavatory without passing through another *bedroom*. Every *bedroom* in a *dwelling unit* shall have access to not less than one water closet and lavatory located in the same story as the *bedroom* or an adjacent story.

**404.4.4 Prohibited occupancy.** Kitchens and nonhabitable spaces shall not be used for sleeping purposes.

**404.4.5 Other requirements.** *Bedrooms* shall comply with the applicable provisions of this code including, but not limited to, the light, *ventilation*, room area, ceiling height and room width requirements of this chapter; the plumbing facilities and water-heating facilities requirements of Chapter 5; the heating facilities and electrical receptacle requirements of Chapter 6; and the smoke detector and emergency escape requirements of Chapter 7.

**404.5 Overcrowding.** *Dwelling units* shall not be occupied by more *occupants* than permitted by the minimum area requirements of Table 404.5.

SPACE	MINIMUM AREA IN SQUARE FEET		
	1-2 occupants	3-5 occupants	6 or more occupants
Living room <sup>a,b</sup>	120	120	150
Dining room <sup>a,b</sup>	No requirement	80	100
Bedrooms	Shall comply with Section 404.4.1		

For SI: 1 square foot = 0.0929 m<sup>2</sup>.  
a. See Section 404.5.2 for combined living room/dining room spaces.  
b. See Section 404.5.1 for limitations on determining the minimum *occupancy* area for sleeping purposes.

**404.5.1 Sleeping area.** The minimum *occupancy* area required by Table 404.5 shall not be included as a sleeping area in determining the minimum *occupancy* area for sleeping purposes. Sleeping areas shall comply with Section 404.4.



**LIGHT, VENTILATION AND OCCUPANCY LIMITATIONS**

**404.5.2 Combined spaces.** Combined living room and dining room spaces shall comply with the requirements of Table 404.5 if the total area is equal to that required for separate rooms and if the space is located so as to function as a combination living room/dining room.

**404.6 Efficiency unit.** Nothing in this section shall prohibit an efficiency living unit from meeting the following requirements:

1. A unit occupied by not more than one *occupant* shall have a minimum clear floor area of 120 square feet (11.2 m<sup>2</sup>). A unit occupied by not more than two *occupants* shall have a minimum clear floor area of 190 square feet (17.7 m<sup>2</sup>). A unit occupied by three *occupants* shall have a minimum clear floor area of 260 square feet (24.2 m<sup>2</sup>). These required areas shall be exclusive of the areas required by Items 2 and 3.
2. The unit shall be provided with a kitchen sink, cooking appliance and refrigeration facilities, each having a minimum clear working space of 30 inches (762 mm) in front. Light and *ventilation* conforming to this code shall be provided.
3. The unit shall be provided with a separate *bathroom* containing a water closet, lavatory and bathtub or shower.
4. The maximum number of *occupants* shall be three.

**404.7 Food preparation.** Spaces to be occupied for food preparation purposes shall contain suitable space and equipment to store, prepare and serve foods in a sanitary manner. There shall be adequate facilities and services for the sanitary disposal of food wastes and refuse, including facilities for temporary storage.

## PLUMBING FACILITIES AND FIXTURE REQUIREMENTS

**User notes:****About this chapter:**

Chapter 5 establishes minimum sanitary and clean conditions in occupied buildings by containing requirements for the installation, maintenance and location of plumbing systems and facilities, including the water supply system, water heating appliances, sewage disposal systems and related plumbing fixtures. Chapter 5 includes requirements for providing potable water to a building and the basic fixtures to effectively utilize and dispose of that water.

**SECTION 501—GENERAL**

**501.1 Scope.** The provisions of this chapter shall govern the minimum plumbing systems, facilities and plumbing fixtures to be provided.

**501.2 Responsibility.** The *owner* of the *structure* shall provide and maintain such plumbing facilities and plumbing fixtures in compliance with these requirements. A *person* shall not occupy as *owner-occupant* or permit another *person* to occupy any *structure* or *premises* that does not comply with the requirements of this chapter.

**SECTION 502—REQUIRED FACILITIES**

**[P] 502.1 Dwelling units.** Every *dwelling unit* shall contain its own bathtub or shower, lavatory, water closet and kitchen sink that shall be maintained in a sanitary, safe working condition. The lavatory shall be placed in the same room as the water closet or located in close proximity to the door leading directly into the room in which such water closet is located. A kitchen sink shall not be used as a substitute for the required lavatory.

**[P] 502.2 Rooming houses.** Not less than one water closet, lavatory and bathtub or shower shall be supplied for each four *rooming units*.

**[P] 502.3 Hotels.** Where private water closets, lavatories and baths are not provided, one water closet, one lavatory and one bathtub or shower having access from a public hallway shall be provided for each 10 *occupants*.

**[P] 502.4 Employees' facilities.** Not less than one water closet, one lavatory and one drinking facility shall be available to employees.

**[P] 502.4.1 Drinking facilities.** Drinking facilities shall be a drinking fountain, water cooler, bottled water cooler or disposable cups next to a sink or water dispenser. Drinking facilities shall not be located in *toilet rooms* or *bathrooms*.

**[P] 502.5 Public toilet facilities.** Public toilet facilities shall be maintained in a safe, sanitary and working condition in accordance with the *International Plumbing Code*. Except for periodic maintenance or cleaning, public access and use shall be provided to the toilet facilities at all times during *occupancy* of the *premises*.

**SECTION 503—TOILET ROOMS**

**[P] 503.1 Privacy.** *Toilet rooms* and *bathrooms* shall provide privacy and shall not constitute the only passageway to a hall or other space, or to the exterior. A door and interior locking device shall be provided for all common or shared *bathrooms* and *toilet rooms* in a multiple dwelling.

**[P] 503.2 Location.** *Toilet rooms* and *bathrooms* serving hotel units, *rooming units* or dormitory units or *housekeeping units*, shall have access by traversing not more than one flight of stairs and shall have access from a common hall or passageway.

**[P] 503.3 Location of employee toilet facilities.** Toilet facilities shall have access from within the employees' working area. The required toilet facilities shall be located not more than one story above or below the employees' working area and the path of travel to such facilities shall not exceed a distance of 500 feet (152 m). Employee facilities shall either be separate facilities or combined employee and public facilities.

**Exception:** Facilities that are required for employees in storage *structures* or kiosks, which are located in adjacent *structures* under the same ownership, lease or control, shall not exceed a travel distance of 500 feet (152 m) from the employees' regular working area to the facilities.

**[P] 503.4 Floor surface.** In other than *dwelling units*, every *toilet room* floor shall be maintained to be a smooth, hard, nonabsorbent surface to permit such floor to be easily kept in a clean and sanitary condition.

**SECTION 504—PLUMBING SYSTEMS AND FIXTURES**

**[P] 504.1 General.** Plumbing fixtures shall be properly installed and maintained in working order, and shall be kept free from obstructions, leaks and defects and be capable of performing the function for which such plumbing fixtures are designed. Plumbing fixtures shall be maintained in a safe, sanitary and functional condition.

**[P] 504.2 Fixture clearances.** Plumbing fixtures shall have adequate clearances for usage and cleaning.

## PLUMBING FACILITIES AND FIXTURE REQUIREMENTS

[P] **504.3 Plumbing system hazards.** Where it is found that a plumbing system in a *structure* constitutes a hazard to the *occupants* or the *structure* by reason of inadequate service, inadequate venting, cross connection, backsiphonage, improper installation, *deterioration* or damage or for similar reasons, the *code official* shall require the defects to be corrected to eliminate the hazard.

### SECTION 505—WATER SYSTEM

**505.1 General.** Every sink, lavatory, bathtub or shower, drinking fountain, water closet or other plumbing fixture shall be properly connected to either a public water system or to an *approved* private water system. Kitchen sinks, lavatories, laundry facilities, bathtubs and showers shall be supplied with hot or tempered and cold running water in accordance with the *International Plumbing Code*.

[P] **505.2 Contamination.** The water supply shall be maintained free from contamination, and all water inlets for plumbing fixtures shall be located above the flood-level rim of the fixture. Shampoo basin faucets, janitor sink faucets and other hose bibs or faucets to which hoses are attached and left in place, shall be protected by an *approved* atmospheric-type vacuum breaker or an *approved* permanently attached hose connection vacuum breaker.

[P] **505.3 Supply.** The water supply system shall be installed and maintained to provide a supply of water to plumbing fixtures, devices and appurtenances in sufficient volume and at pressures adequate to enable the fixtures to function properly, safely, and free from defects and leaks.

[P] **505.4 Water heating facilities.** Water heating facilities shall be properly installed, maintained and capable of providing an adequate amount of water to be drawn at every required sink, lavatory, bathtub, shower and laundry facility at a temperature not less than 110°F (43°C). A gas-burning water heater shall not be located in any *bathroom, toilet room, bedroom* or other occupied room normally kept closed, unless adequate combustion air is provided. An *approved* combination temperature and pressure-relief valve and relief valve discharge pipe shall be properly installed and maintained on water heaters.

[P] **505.5 Nonpotable water reuse systems.** Nonpotable water reuse systems and rainwater collection and conveyance systems shall be maintained in a safe and sanitary condition. Where such systems are not properly maintained, the systems shall be repaired to provide for safe and sanitary conditions, or the system shall be abandoned in accordance with Section 505.5.1.

[P] **505.5.1 Abandonment of systems.** Where a nonpotable water reuse system or a rainwater collection and distribution system is not maintained or the *owner* ceases use of the system, the system shall be abandoned in accordance with Section 1301.10 of the *International Plumbing Code*.

### SECTION 506—SANITARY DRAINAGE SYSTEM

[P] **506.1 General.** Plumbing fixtures shall be properly connected to either a public sewer system or to an *approved* private sewage disposal system.

[P] **506.2 Maintenance.** Every plumbing stack, vent, waste and sewer line shall function properly and be kept free from obstructions, leaks and defects.

[P] **506.3 Grease interceptors.** Grease interceptors and automatic grease removal devices shall be maintained in accordance with this code and the manufacturer's installation instructions. Grease interceptors and automatic grease removal devices shall be regularly serviced and cleaned to prevent the discharge of oil, grease, and other substances harmful or hazardous to the building drainage system, the public sewer, the private sewage disposal system or the sewage treatment plant or processes. Records of maintenance, cleaning and repairs shall be available for inspection by the *code official*.

### SECTION 507—STORM DRAINAGE

[P] **507.1 General.** Drainage of roofs and paved areas, *yards* and courts, and other open areas on the *premises* shall not be discharged in a manner that creates a public nuisance.

## MECHANICAL AND ELECTRICAL REQUIREMENTS

**User notes:****About this chapter:**

Chapter 6 establishes minimum performance requirements for heating, electrical and mechanical facilities serving existing structures, such as heating and air-conditioning equipment, appliances and their supporting systems; water heating equipment, appliances and systems; cooking equipment and appliances; ventilation and exhaust equipment; gas and liquid fuel distribution piping and components; fireplaces and solid fuel-burning appliances; chimneys and vents; electrical services; lighting fixtures; electrical receptacle outlets; electrical distribution system equipment, devices and wiring; and elevators, escalators and dumbwaiters.

**SECTION 601—GENERAL**

**601.1 Scope.** The provisions of this chapter shall govern the minimum mechanical and electrical facilities and equipment to be provided.

**601.2 Responsibility.** The *owner* of the *structure* shall provide and maintain mechanical and electrical facilities and equipment in compliance with these requirements. A *person* shall not occupy as *owner-occupant* or permit another *person* to occupy any *premises* that does not comply with the requirements of this chapter.

**SECTION 602—HEATING FACILITIES**

**602.1 Facilities required.** Heating facilities shall be provided in *structures* as required by this section.

**602.2 Residential occupancies.** Dwellings shall be provided with heating facilities capable of maintaining a room temperature of 68°F (20°C) in all habitable rooms, *bathrooms* and *toilet rooms* based on the winter outdoor design temperature for the locality indicated in Appendix D of the *International Plumbing Code*. Cooking appliances shall not be used, nor shall portable unvented fuel-burning space heaters be used, as a means to provide required heating. The installation of one or more portable space heaters shall not be used to achieve compliance with this section.

**Exception:** In areas where the average monthly temperature is above 30°F (-1°C), a minimum temperature of 65°F (18°C) shall be maintained.

**602.3 Heat supply.** Every *owner* and *operator* of any building who rents, leases or lets one or more *dwelling units* or *sleeping units* on terms, either expressed or implied, to furnish heat to the *occupants* thereof shall supply heat during the period from [DATE] to [DATE] to maintain a minimum temperature of 68°F (20°C) in all habitable rooms, *bathrooms* and *toilet rooms*.

**Exceptions:**

1. When the outdoor temperature is below the winter outdoor design temperature for the locality, maintenance of the minimum room temperature shall not be required provided that the heating system is operating at its full design capacity. The winter outdoor design temperature for the locality shall be as indicated in Appendix D of the *International Plumbing Code*.
2. In areas where the average monthly temperature is above 30°F (-1°C), a minimum temperature of 65°F (18°C) shall be maintained.

**602.4 Occupiable work spaces.** Indoor occupiable work spaces shall be supplied with heat during the period from [DATE] to [DATE] to maintain a minimum temperature of 65°F (18°C) during the period the spaces are occupied.

**Exceptions:**

1. Processing, storage and operation areas that require cooling or special temperature conditions.
2. Areas in which persons are primarily engaged in vigorous physical activities.

**602.5 Room temperature measurement.** The required room temperatures shall be measured 3 feet (914 mm) above the floor near the center of the room and 2 feet (610 mm) inward from the center of each exterior wall.

**SECTION 603—MECHANICAL EQUIPMENT**

**603.1 Mechanical equipment and appliances.** Mechanical equipment, appliances, fireplaces, solid fuel-burning appliances, cooking appliances and water heating appliances shall be properly installed and maintained in a safe working condition, and shall be capable of performing the intended function.

**603.2 Removal of combustion products.** Fuel-burning equipment and appliances shall be connected to an *approved* chimney or vent.

**Exception:** Fuel-burning equipment and appliances that are *labeled* for unvented operation.

**603.3 Clearances.** Required clearances to combustible materials shall be maintained.

**603.4 Safety controls.** Safety controls for fuel-burning equipment shall be maintained in effective operation.

**603.5 Combustion air.** A supply of air for complete combustion of the fuel and for *ventilation* of the space containing the fuel-burning equipment shall be provided for the fuel-burning equipment.

## MECHANICAL AND ELECTRICAL REQUIREMENTS

**603.6 Energy conservation devices.** Devices intended to reduce fuel consumption by attachment to a fuel-burning appliance, to the fuel supply line thereto, or to the vent outlet or vent piping therefrom, shall not be installed unless *labeled* for such purpose and the installation is specifically *approved*.

### SECTION 604—ELECTRICAL FACILITIES

**604.1 Facilities required.** Every occupied building shall be provided with an electrical system in compliance with the requirements of this section and Section 605.

**604.2 Service.** The size and usage of appliances and equipment shall serve as a basis for determining the need for additional facilities in accordance with NFPA 70. *Dwelling units* shall be served by a three-wire, 120/240 volt, single-phase electrical service having a minimum rating of 60 amperes.

**604.3 Electrical system hazards.** Where it is found that the electrical system in a *structure* constitutes a hazard to the *occupants* or the *structure* by reason of inadequate service, improper fusing, insufficient receptacle and lighting outlets, improper wiring or installation, *deterioration* or *damage*, or for similar reasons, the *code official* shall require the defects to be corrected to eliminate the hazard.

**604.3.1 Abatement of electrical hazards associated with water exposure.** The provisions of this section shall govern the repair and replacement of electrical systems and equipment that have been exposed to water.

**604.3.1.1 Electrical equipment.** Electrical distribution equipment, motor circuits, power equipment, transformers, wire, cable, flexible cords, wiring devices, ground fault circuit interrupters, surge protectors, molded case circuit breakers, low-voltage fuses, luminaires, ballasts, motors and electronic control, signaling and communication equipment that have been exposed to water shall be replaced in accordance with the provisions of the *International Building Code*.

**Exceptions:** The following equipment shall be allowed to be repaired where an inspection report from the equipment manufacturer or *approved* manufacturer's representative indicates that the equipment has not sustained damage that requires replacement:

1. Enclosed switches, rated not more than 600 volts or less.
2. Busway, rated not more than 600 volts.
3. Panelboards, rated not more than 600 volts.
4. Switchboards, rated not more than 600 volts.
5. Fire pump controllers, rated not more than 600 volts.
6. Manual and magnetic motor controllers.
7. Motor control centers.
8. Alternating current high-voltage circuit breakers.
9. Low-voltage power circuit breakers.
10. Protective relays, meters and current transformers.
11. Low- and medium-voltage switchgear.
12. Liquid-filled transformers.
13. Cast-resin transformers.
14. Wire or cable that is suitable for wet locations and whose ends have not been exposed to water.
15. Wire or cable, not containing fillers, that is suitable for wet locations and whose ends have not been exposed to water.
16. Luminaires that are listed as submersible.
17. Motors.
18. Electronic control, signaling and communication equipment.

**604.3.2 Abatement of electrical hazards associated with fire exposure.** The provisions of this section shall govern the repair and replacement of electrical systems and equipment that have been exposed to fire.

**604.3.2.1 Electrical equipment.** Electrical switches, receptacles and fixtures, including furnace, water heating, security system and power distribution circuits, that have been exposed to fire, shall be replaced in accordance with the provisions of the *International Building Code*.

**Exception:** Electrical switches, receptacles and fixtures that shall be allowed to be repaired where an inspection report from the equipment manufacturer or *approved* manufacturer's representative indicates that the equipment has not sustained damage that requires replacement.

### SECTION 605—ELECTRICAL EQUIPMENT

**605.1 Installation.** Electrical equipment, wiring and appliances shall be properly installed and maintained in a safe and *approved* manner.

**605.2 Receptacles.** Every *habitable space* in a dwelling shall contain not less than two separate and remote receptacle outlets. Every laundry area shall contain not less than one grounding-type receptacle or a receptacle with a ground fault circuit interrupter. Every

*bathroom* shall contain not less than one receptacle. Any new *bathroom* receptacle outlet shall have ground fault circuit interrupter protection. All receptacle outlets shall have the appropriate faceplate cover for the location.

**605.3 Luminaires.** Every public hall, interior stairway, *toilet room*, kitchen, *bathroom*, laundry room, boiler room and furnace room shall contain not less than one electric luminaire. Pool and spa luminaires over 15 V shall have ground fault circuit interrupter protection.

**605.4 Wiring.** Flexible cords shall not be used for permanent wiring, or for running through doors, windows, or cabinets, or concealed within walls, floors, or ceilings.

### SECTION 606—ELEVATORS, ESCALATORS AND DUMBWAITERS

**606.1 General.** Elevators, dumbwaiters and escalators shall be maintained in compliance with ASME A17.1. The most current certificate of inspection shall be on display at all times within the elevator or attached to the escalator or dumbwaiter, be available for public inspection in the office of the building *operator* or be posted in a publicly conspicuous location *approved by the code official*. The inspection and tests shall be performed at not less than the periodic intervals listed in ASME A17.1, Appendix N, except where otherwise specified by the authority having jurisdiction.

**606.2 Elevators.** In buildings equipped with passenger elevators, not less than one elevator shall be maintained in operation at all times when the building is occupied.

**Exception:** Buildings equipped with only one elevator shall be permitted to have the elevator temporarily out of service for testing or servicing.

**606.3 Private residence elevators.** Requirements for private residence elevators shall be in accordance with Sections 606.3.1 through 606.3.3.

**606.3.1 General.** The maintenance of elevators in private residences shall conform to Section 5.3 of ASME A17.1/CSA B44.

**606.3.2 Hoistway enclosures.** Hoistway enclosures shall comply with Section 5.3.1.1 of ASME A17.1/CSA B44.

**606.3.3 Hoistway Opening Protection.** Hoistway landing doors for private residence elevators shall comply with Sections 5.3.1.8.1 through 5.3.1.8.3 of ASME A17.1/CSA B44 or Sections 10.1.4.1 through 10.1.4.3 of ASME A17.3.



### SECTION 607—DUCT SYSTEMS

**607.1 General.** Duct systems shall be maintained free of obstructions and shall be capable of performing the required function.

**607.2 Clothes dryer exhaust duct system maintenance.** The lint trap, mechanical and heating components, and the exhaust duct system of a clothes dryer shall undergo periodic removal of accumulations of lint in accordance with the manufacturer's operating instructions to prevent obstruction of exhaust air and products of combustion.



## FIRE SAFETY REQUIREMENTS

## User notes:

**About this chapter:**

*Chapter 7 establishes fire safety requirements for existing structures by providing requirements for means of egress, including path of travel, required egress width, means of egress doors and emergency escape openings, and for the maintenance of fire-resistance-rated assemblies, fire protection systems, and carbon monoxide alarm and detection systems.*

## SECTION 701—GENERAL

**701.1 Scope.** The provisions of this chapter shall govern the minimum conditions and standards for fire safety relating to *structures* and exterior *premises*, including fire safety facilities and equipment to be provided.

**701.2 Responsibility.** The *owner* of the *premises* shall provide and maintain such fire safety facilities and equipment in compliance with these requirements. A *person* shall not occupy as *owner-occupant* or permit another *person* to occupy any *premises* that do not comply with the requirements of this chapter.

## SECTION 702—MEANS OF EGRESS

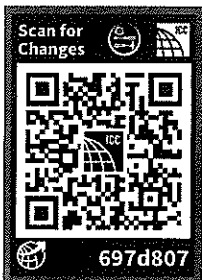

**[BE] 702.1 General.** A safe, continuous and unobstructed path of travel shall be provided from any point in a building or *structure* to the *public way*. Means of egress shall comply with the code under which the building was constructed.

**[BE] 702.2 Aistes.** The required width of aisles in accordance with the code under which the building was constructed shall be unobstructed.

**[BE] 702.3 Locked doors.** Means of egress doors shall be readily openable from the side from which egress is to be made without the need for keys, special knowledge or effort, except where the door hardware conforms to that permitted by the *International Building Code*.

**[BE] 702.4 Emergency escape and rescue openings.** Required emergency escape and rescue openings shall be maintained in accordance with the code in effect at the time of construction, and both of the following:

1. Required *emergency escape and rescue openings* shall be operational from the inside of the room without the use of keys or tools.
2. Bars, grilles, grates or similar devices are permitted to be placed over *emergency escape and rescue openings* provided that the minimum net clear opening size complies with the code that was in effect at the time of construction and the unit is equipped with smoke alarms installed in accordance with Section 907.2.1.1 of the *International Building Code*. Such devices shall be releasable or removable from the inside without the use of a key, tool or force greater than that which is required for normal operation of the escape and rescue opening.

## SECTION 703—FIRE-RESISTANCE RATINGS

**[BF] 703.1 Fire-resistance-rated assemblies.** The provisions of this chapter shall govern maintenance of the materials, systems and assemblies used for structural fire resistance and fire-resistance-rated construction separation of adjacent spaces to safeguard against the spread of fire and smoke within a building and the spread of fire to or from buildings.

**[BF] 703.2 Unsafe conditions.** Where any components are not maintained and do not function as intended or do not have the fire resistance required by the code under which the building was constructed or altered, such components or portions thereof shall be deemed unsafe conditions in accordance with Section 115.1.1 of the *International Fire Code*. Components or portions thereof determined to be unsafe shall be repaired or replaced to conform to that code under which the building was constructed or altered. Where the condition of components is such that any building, *structure* or portion thereof presents an *imminent danger* to the *occupants* of the building, *structure* or portion thereof, the *fire code official* shall act in accordance with Section 115.2 of the *International Fire Code*.

**[BF] 703.3 Maintenance.** The required fire-resistance rating of fire-resistance-rated construction, including walls, firestops, shaft enclosures, partitions, smoke barriers, floors, fire-resistive coatings and sprayed fire-resistant materials applied to structural members and joint systems, shall be maintained. Such elements shall be visually inspected annually by the *owner* and repaired, restored or replaced where damaged, altered, breached or penetrated. Records of inspections and repairs shall be maintained. Where concealed, such elements shall not be required to be visually inspected by the *owner* unless the concealed space is accessible by the removal or movement of a panel, access door, ceiling tile or entry to the space. Openings made therein for the passage of pipes, electrical conduit, wires, ducts, air transfer and any other reason shall be protected with *approved* methods capable of resisting the passage of smoke and fire. Openings through fire-resistance-rated assemblies shall be protected by self- or automatic-closing doors of *approved* construction meeting the fire protection requirements for the assembly.

**[BF] 703.3.1 Fire blocking and draft stopping.** Required fire blocking and draft stopping in combustible concealed spaces shall be maintained to provide continuity and integrity of the construction.

**[BF] 703.3.2 Smoke barriers and smoke partitions.** Required smoke barriers and smoke partitions shall be maintained to prevent the passage of smoke. Openings protected with *approved* smoke barrier doors or smoke dampers shall be maintained in accordance with NFPA 105.

**[BF] 703.3.3 Fire walls, fire barriers, and fire partitions.** Required fire walls, fire barriers and fire partitions shall be maintained to prevent the passage of fire. Openings protected with *approved* doors or fire dampers shall be maintained in accordance with NFPA 80.

**[BF] 703.4 Opening protectives.** Opening protectives shall be maintained in an operative condition in accordance with NFPA 80. The application of field-applied labels associated with the maintenance of opening protectives shall follow the requirements of the *approved* third-party certification organization accredited for listing the opening protective. Fire doors and smoke barrier doors shall not be blocked or obstructed, or otherwise made inoperable. Fusible links shall be replaced whenever fused or damaged. Fire door assemblies shall not be modified.

**[BF] 703.4.1 Signs.** Where required by the *code official*, a sign shall be permanently displayed on or near each fire door in letters not less than 1 inch (25 mm) high to read as follows:

1. For doors designed to be kept normally open: FIRE DOOR – DO NOT BLOCK.
2. For doors designed to be kept normally closed: FIRE DOOR – KEEP CLOSED.

**[BF] 703.4.2 Hold-open devices and closers.** Hold-open devices and automatic door closers shall be maintained. During the period that such a device is out of service for repairs, the door it operates shall remain in the closed position.

**[BF] 703.4.3 Door operation.** Swinging fire doors shall close from the full-open position and latch automatically. The door closer shall exert enough force to close and latch the door from any partially open position.

**[BF] 703.5 Ceilings.** The hanging and displaying of salable goods and other decorative materials from acoustical ceiling systems that are part of a fire-resistance-rated horizontal assembly shall be prohibited.

**[BF] 703.6 Testing.** Horizontal and vertical sliding and rolling fire doors shall be inspected and tested annually to confirm operation and full closure. Records of inspections and testing shall be maintained.

**[BF] 703.7 Vertical shafts.** Interior vertical shafts, including stairways, elevator hoistways and service and utility shafts, which connect two or more stories of a building shall be enclosed or protected as required in Chapter 11 of the *International Fire Code*. New floor openings in existing buildings shall comply with the *International Building Code*.

**[BF] 703.8 Opening protective closers.** Where openings are required to be protected, opening protectives shall be maintained self-closing or automatic-closing by smoke detection. Existing fusible-link-type automatic door-closing devices shall be replaced if the fusible link rating exceeds 135°F (57°C).

## SECTION 704—FIRE PROTECTION SYSTEMS

**[F] 704.1 Inspection, testing and maintenance.** Fire protection and life safety systems shall be maintained in accordance with the *International Fire Code* in an operative condition at all times, and shall be replaced or repaired where defective.

**[F] 704.1.1 Fire protection and life safety systems.** Fire protection and life safety systems shall be installed, repaired, operated and maintained in accordance with this code the *International Fire Code* and the *International Building Code*.

**[F] 704.1.2 Required fire protection and life safety systems.** Fire protection and life safety systems required by this code, the *International Fire Code* or the *International Building Code* shall be installed, repaired, operated, tested and maintained in accordance with this code. A fire protection and life safety system for which a design option, exception or reduction to the provisions of this code, the *International Fire Code* or the *International Building Code* has been granted shall be considered to be a required system.

**[F] 704.1.3 Fire protection systems.** Fire protection systems shall be inspected, maintained and tested in accordance with the following *International Fire Code* requirements.

1. Automatic sprinkler systems, see Section 903.5.
2. Automatic fire-extinguishing systems protecting commercial cooking systems, see Section 904.13.5.
3. Automatic water mist extinguishing systems, see Section 904.11.3.
4. Carbon dioxide extinguishing systems, see Section 904.8.
5. Carbon monoxide alarms and carbon monoxide detection systems, see Section 915.6.
6. Clean-agent extinguishing systems, see Section 904.10.
7. Dry-chemical extinguishing systems, see Section 904.6.
8. Fire alarm and fire detection systems, see Section 907.8.
9. Fire department connections, see Sections 912.4 and 912.7.
10. Fire pumps, see Section 913.5.
11. Foam extinguishing systems, see Section 904.7.
12. Halon extinguishing systems, see Section 904.9.
13. Single- and multiple-station smoke alarms, see Section 907.2.9.2.



## FIRE SAFETY REQUIREMENTS

14. Smoke and heat vents and mechanical smoke removal systems, see Section 910.5.
15. Smoke control systems, see Section 909.22.
16. Wet-chemical extinguishing systems, see Section 904.5.
17. Duct and air transfer openings, see Section 706.1.

**[F] 704.2 Standards.** Fire protection systems shall be inspected, tested and maintained in accordance with the referenced standards listed in Table 704.2 and as required in this section.

SYSTEM	STANDARD
Portable fire extinguishers	NFPA 10
Carbon dioxide fire-extinguishing system	NFPA 12
Halon 1301 fire-extinguishing systems	NFPA 12A
Dry-chemical extinguishing systems	NFPA 17
Wet-chemical extinguishing systems	NFPA 17A
Water-based fire protection systems	NFPA 25
Fire alarm systems	NFPA 72
Fire dampers	NFPA 80
Smoke dampers	NFPA 105
Smoke and heat vents	NFPA 204
Water-mist systems	NFPA 750
Clean-agent extinguishing systems	NFPA 2001

**[F] 704.2.1 Records.** Records shall be maintained of all system inspections, tests and maintenance in accordance with Section 109.3 of the *International Fire Code*.

**[F] 704.2.2 Records information.** Initial records shall include the: name of the installation contractor; type of components installed; manufacturer of the components; location and number of components installed per floor; and manufacturers' operation and maintenance instruction manuals. Such records shall be maintained for the life of the installation.

**[F] 704.3 Systems out of service.** Where a required fire protection system is out of service, the fire department and the fire code official shall be notified immediately and, where required by the fire code official, either the building shall be evacuated or an approved fire watch shall be provided for all occupants left unprotected by the shutdown until the fire protection system has been returned to service. Where utilized, fire watches shall be provided with not less than one approved means for notification of the fire department and shall not have duties beyond performing constant patrols of the protected premises and keeping watch for fires. Actions shall be taken in accordance with Section 901.7 of the *International Fire Code* to bring the systems back in service.

**Exception:** Facilities with an approved notification and impairment management program. The notification and impairment program for water-based fire protection systems shall comply with NFPA 25.

**[F] 704.3.1 Emergency impairments.** Where unplanned impairments of fire protection systems occur, appropriate emergency action shall be taken to minimize potential injury and damage. The impairment coordinator shall implement the steps outlined in Section 901.7.4 of the *International Fire Code*.

**[F] 704.4 Removal of or tampering with equipment.** It shall be unlawful for any person to remove, tamper with or otherwise disturb any fire protection or life safety system required by this code except for the purposes of extinguishing fire, training, recharging or making necessary repairs.

**[F] 704.4.1 Removal of or tampering with appurtenances.** Locks, gates, doors, barricades, chains, enclosures, signs, tags and seals that have been installed by or at the direction of the fire code official shall not be removed, unlocked, destroyed or tampered with in any manner.

**[F] 704.4.2 Removal of existing occupant-use hose lines.** The fire code official is authorized to permit the removal of existing occupant-use hose lines where all of the following apply:

1. The installation is not required by the *International Fire Code* or the *International Building Code*.
2. The hose line would not be utilized by trained personnel or the fire department.
3. The remaining outlets are compatible with local fire department fittings.

**[F] 704.4.3 Termination of monitoring service.** For fire alarm systems required to be monitored by the *International Fire Code*, notice shall be made to the fire code official whenever alarm monitoring services are terminated. Notice shall be made in writing by the provider of the monitoring service being terminated.

**[F] 704.5 Fire department connection.** Where the fire department connection is not visible to approaching fire apparatus, the fire department connection shall be indicated by an approved sign mounted on the street front or on the side of the building. Such sign

shall have the letters “FDC” not less than 6 inches (152 mm) high and words in letters not less than 2 inches (51 mm) high or an arrow to indicate the location. Such signs shall be subject to the approval of the fire *code official*.

**[F] 704.5.1 Fire department connection access.** Ready access to fire department connections shall be maintained at all times and without obstruction by fences, bushes, trees, walls or any other fixed or movable object. Access to fire department connections shall be *approved* by the fire chief.

**Exception:** Fences, where provided with an access gate equipped with a sign complying with the legend requirements of Section 912.5 of the *International Fire Code* and a means of emergency operation. The gate and the means of emergency operation shall be *approved* by the fire chief and maintained operational at all times.

**[F] 704.5.2 Clear space around connections.** A working space of not less than 36 inches (914 mm) in width, 36 inches (914 mm) in depth and 78 inches (1981 mm) in height shall be provided and maintained in front of and to the sides of wall-mounted fire department connections and around the circumference of free-standing fire department connections.

**[F] 704.6 Single- and multiple-station smoke alarms.** Single- and multiple-station smoke alarms shall be installed in existing Group I-1 and R *occupancies* in accordance with Sections 704.6.1 through 704.6.3.

**[F] 704.6.1 Where required.** Existing Group I-1 and R *occupancies* shall be provided with single-station smoke alarms in accordance with Sections 704.6.1.1 through 704.6.1.4. Interconnection and power sources shall be in accordance with Sections 704.6.2 and 704.6.3.

**Exceptions:**

1. Where the code that was in effect at the time of construction required smoke alarms and smoke alarms complying with those requirements are already provided.
2. Where smoke alarms have been installed in *occupancies* and dwellings that were not required to have them at the time of construction, additional smoke alarms shall not be required provided that the existing smoke alarms comply with requirements that were in effect at the time of installation.
3. Where smoke detectors connected to a fire alarm system have been installed as a substitute for smoke alarms.

**[F] 704.6.1.1 Group R-1.** Single- or multiple-station smoke alarms shall be installed in all of the following locations in Group R-1:

1. In sleeping areas.
2. In every room in the path of the means of egress from the sleeping area to the door leading from the *sleeping unit*.
3. In each story within the *sleeping unit*, including *basements*. For *sleeping units* with split levels and without an intervening door between the adjacent levels, a smoke alarm installed on the upper level shall suffice for the adjacent lower level provided that the lower level is less than one full story below the upper level.

**[F] 704.6.1.2 Groups R-2, R-3, R-4 and I-1.** Single or multiple-station smoke alarms shall be installed and maintained in Groups R-2, R-3, R-4 and I-1 regardless of *occupant load* at all of the following locations:

1. On the ceiling or wall outside of each separate sleeping area in the immediate vicinity of *bedrooms*.
2. In each room used for sleeping purposes.
3. In each story within a *dwelling unit*, including *basements* but not including crawl spaces and uninhabitable attics. In *dwellings* or *dwelling units* with split levels and without an intervening door between the adjacent levels, a smoke alarm installed on the upper level shall suffice for the adjacent lower level provided that the lower level is less than one full story below the upper level.

**[F] 704.6.1.3 Installation near cooking appliances.** Smoke alarms shall be installed a minimum of 10 feet (3.0 m) horizontally from a permanently installed cooking appliance.

**Exception:** Smoke alarms shall be permitted to be installed a minimum of 6 feet (1.8 m) horizontally from a permanently installed cooking appliance where necessary to comply with Section 704.6.1.1 or 704.6.1.2.

**[F] 704.6.1.4 Installation near bathrooms.** Smoke alarms shall be installed not less than 3 feet (914 mm) horizontally from the door or opening of a *bathroom* that contains a bathtub or shower unless this would prevent placement of a smoke alarm required by Section 704.6.1.1 or 704.6.1.2.

**[F] 704.6.2 Interconnection.** Where more than one smoke alarm is required to be installed within an individual *dwelling* or *sleeping unit*, the smoke alarms shall be interconnected in such a manner that the activation of one alarm will activate all of the alarms in the individual unit. Physical interconnection of smoke alarms shall not be required where listed wireless alarms are installed and all alarms sound upon activation of one alarm. The alarm shall be clearly audible in all *bedrooms* over background noise levels with all intervening doors closed.

**Exceptions:**

1. Interconnection is not required in buildings that are not undergoing *alterations*, repairs or construction of any kind.
2. Smoke alarms in existing areas are not required to be interconnected where *alterations* or repairs do not result in the removal of interior wall or ceiling finishes exposing the structure, unless there is an attic, crawl space or *basement* available that could provide access for interconnection without the removal of interior finishes.

**[F] 704.6.3 Power source.** Single-station smoke alarms shall receive their primary power from the building wiring provided that such wiring is served from a commercial source and shall be equipped with a battery backup. Smoke alarms with integral strobes that are not equipped with battery backup shall be connected to an emergency electrical system. Smoke alarms shall emit a

## FIRE SAFETY REQUIREMENTS

signal when the batteries are low. Wiring shall be permanent and without a disconnecting switch other than as required for over-current protection.

### Exceptions:

1. Smoke alarms are permitted to be solely battery operated in existing buildings where construction is not taking place.
2. Smoke alarms are permitted to be solely battery operated in buildings that are not served from a commercial power source.
3. Smoke alarms are permitted to be solely battery operated in existing areas of buildings undergoing *alterations* or repairs that do not result in the removal of interior walls or ceiling finishes exposing the structure, unless there is an attic, crawl space or *basement* available that could provide access for building wiring without the removal of interior finishes.

**[F] 704.6.4 Smoke detection system.** Smoke detectors listed in accordance with UL 268 and provided as part of the building's fire alarm system shall be an acceptable alternative to single- and multiple-station smoke alarms and shall comply with the following:

1. The fire alarm system shall comply with all applicable requirements in Section 907 of the *International Fire Code*.
2. Activation of a smoke detector in a dwelling or *sleeping unit* shall initiate alarm notification in the *dwelling or sleeping unit* in accordance with Section 907.5.2 of the *International Fire Code*.
3. Activation of a smoke detector in a *dwelling or sleeping unit* shall not activate alarm notification appliances outside of the *dwelling or sleeping unit*, provided that a supervisory signal is generated and monitored in accordance with Section 907.6.6 of the *International Fire Code*.

**[F] 704.7 Single- and multiple-station smoke alarms.** Single- and multiple-station smoke alarms shall be tested and maintained in accordance with the manufacturer's instructions and this code.

**[F] 704.7.1 Replacement.** Smoke alarms shall be replaced where any of the following apply:

1. The smoke alarm fails to respond to operability tests.
2. Where the smoke alarm exceeds 10 years from the date of manufacture marked on the unit, unless an earlier replacement is specified in the manufacturer's instructions.
3. The smoke alarm end-of-life signal is sounded.
4. The smoke alarm date of manufacturer cannot be determined.

## SECTION 705—CARBON MONOXIDE ALARMS AND DETECTION



**[F] 705.1 General.** Carbon monoxide alarms shall be installed in dwellings in accordance with Section 1103.9 of the *International Fire Code*, except that alarms in dwellings covered by the *International Residential Code* shall be installed in accordance with Section R315 of that code.

**[F] 705.2 Carbon monoxide alarms and detectors.** Carbon monoxide alarms and carbon monoxide detection systems shall be maintained in accordance with NFPA 72. Carbon monoxide alarms and carbon monoxide detectors that become inoperable or begin producing end-of-life signals shall be replaced.

## CHAPTER

## 8

## REFERENCED STANDARDS

**User notes:****About this chapter:**

*This code contains numerous references to standards promulgated by other organizations that are used to provide requirements for materials and methods of construction. Chapter 8 contains a comprehensive list of all standards that are referenced in this code. These standards, in essence, are part of this code to the extent of the reference to the standard.*

*This chapter lists the standards that are referenced in various sections of this document. The standards are listed herein by the promulgating agency of the standard, the standard identification, the effective date and title and the section or sections of this document that reference the standard. The application of the referenced standards shall be as specified in Section 102.8.*

**ASME**

American Society of Mechanical Engineers  
Two Park Avenue, New York, NY 10016-5990

**ASME A17.1—2022/CSA B44—2022: Safety Code for Elevators and Escalators**

606.1

**ASME A17.3—2020: Safety Code for Existing Elevators and Escalators**

606.3.3

**ASTM**

ASTM International  
100 Barr Harbor Drive, P.O. Box C700, West Conshohocken, PA 19428-2959

**F1346—1991 (2018): Standard Performance Specification for Safety Covers and Labeling Requirements for All Covers for Swimming Pools, Spas and Hot Tubs**

303.2

**ICC**

International Code Council  
200 Massachusetts Avenue, NW, Suite 250, Washington, DC 20001

**IBC—24: International Building Code®**

102.3, 201.3, 304.1.1, 305.1.1, 306.1.1, 401.3, 604.3.1.1, 604.3.2.1, 702.3, 704.4.2

**ICC 500—2020: ICC/NSSA Standard for the Design and Construction of Storm Shelters**

202, 311.1, 311.2, 311.3

**IEBC—24: International Existing Building Code®**

102.3, 201.3, 304.1.1, 305.1.1, 306.1.1

**IECC—24: International Energy Conservation Code®**

102.3

**IFC—24: International Fire Code®**

102.3, 201.3, 604.3.1.1, 702.1, 702.2, 704.1, 704.1.2, 704.1.3, 704.3, 704.3.1, 704.4.2, 704.4.3, 704.5.1, 704.6.4, 705.1

**IFGC—24: International Fuel Gas Code®**

102.3, 201.3

**IMC—24: International Mechanical Code®**

102.3, 201.3

**IPC—24: International Plumbing Code®**

102.3, 201.3, 502.5, 505.1, 505.5.1, 602.2, 602.3

**IRC—24: International Residential Code®**

102.3, 201.3

**IZC—24: International Zoning Code®**

102.3, 201.3

**NFPA**

National Fire Protection Association  
1 Batterymarch Park, Quincy, MA 02169-7471

**10—22: Standard for Portable Fire Extinguishers**

Table 704.2

**12—22: Standard on Carbon Dioxide Extinguishing Systems**

Table 704.2

## REFERENCED STANDARDS

- 12A—22: Standard on Halon 1301 Fire Extinguishing Systems**  
Table 704.2
- 17—2021: Standard for Dry Chemical Extinguishing Systems**  
Table 704.2
- 17A—2021: Standard for Wet Chemical Extinguishing Systems**  
Table 704.2
- 25—23: Standard for the Inspection, Testing and Maintenance of Water-Based Fire Protection Systems**  
Table 704.2
- 70—23: National Electrical Code**  
102.3, 201.3, 604.2
- 72—22: National Fire Alarm and Signaling Code**  
Table 704.2
- 80—22: Standard for Fire Doors and Other Opening Protectives**  
703.3.3, 703.4, Table 704.2
- 105—22: Standard for Smoke Door Assemblies and Other Opening Protectives**  
703.3.2, Table 704.2
- 204—21: Standard for Smoke and Heat Venting**  
Table 704.2
- 750—23: Standard on Water Mist Fire Protection Systems**  
Table 704.2
- 2001—22: Standard on Clean Agent Fire Extinguishing Systems**  
Table 704.2

**UL**

Underwriters Laboratories, LLC  
333 Pfingsten Road, Northbrook, IL 60062

- 268—2016: Smoke Detectors for Fire Alarm Systems—with revisions through July 2016**  
704.6.4

## APPENDIX

## A

## BOARDING STANDARD

The provisions contained in this appendix are not mandatory unless specifically referenced in the adopting ordinance.

**User notes:**

**About this appendix:** Appendix A provides minimum specifications for boarding a structure. This can be utilized by a jurisdiction as a set of minimum requirements in order to result in consistent boarding quality. These requirements also provide a reasonable means to eliminate having to approve numerous methods or materials for the boarding and securing of a structure. It is important to note that the provisions of Appendix A are not mandatory unless specifically referenced in the adopting ordinance of the authority having jurisdiction.

**Code development reminder:** Code change proposals to sections in this appendix will be considered by the IPMC Code Development Committee during the 2025 (Group B) Code Development Cycle.

**SECTION A101—GENERAL**

**A101.1 General.** Windows and doors shall be boarded in an *approved* manner to prevent entry by unauthorized persons and shall be painted to correspond to the color of the existing *structure*.

**SECTION A102—MATERIALS**

**A102.1 Boarding sheet material.** Boarding sheet material shall be minimum  $\frac{1}{2}$ -inch-thick (12.7 mm) wood structural panels complying with the *International Building Code*.

**A102.2 Boarding framing material.** Boarding framing material shall be minimum nominal 2-inch by 4-inch (51 mm by 102 mm) solid sawn lumber complying with the *International Building Code*.

**A102.3 Boarding fasteners.** Boarding fasteners shall be minimum  $\frac{3}{8}$ -inch-diameter (9.5 mm) carriage bolts of such a length as required to penetrate the assembly and as required to adequately attach the washers and nuts. Washers and nuts shall comply with the *International Building Code*.

**SECTION A103—INSTALLATION**

**A103.1 Boarding installation.** The boarding installation shall be in accordance with Figures A103.1(1) and A103.1(2) and Sections A103.2 through A103.5.

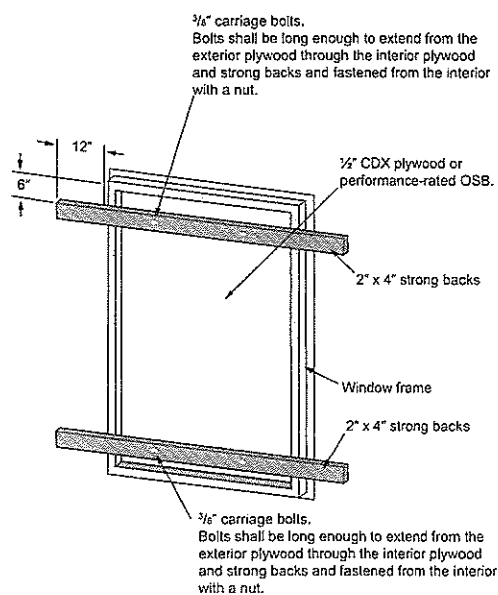
**FIGURE A103.1(1)—BOARDING OF DOOR OR WINDOW**

For SI: 1 inch = 25.4 mm.

## APPENDIX A—BOARDING STANDARD

FIGURE A103.1(2)—BOARDING OF DOOR WALL

½" CDX PLYWOOD OR PERFORMANCE-RATED OSB SHALL BE SECURED TO HEADER, BASE PLATE, STUDS, STILES, AND EDGE BLOCKING USING ALTERNATE SCREWS AND NAILS AT A MAXIMUM OF 6" O.C.

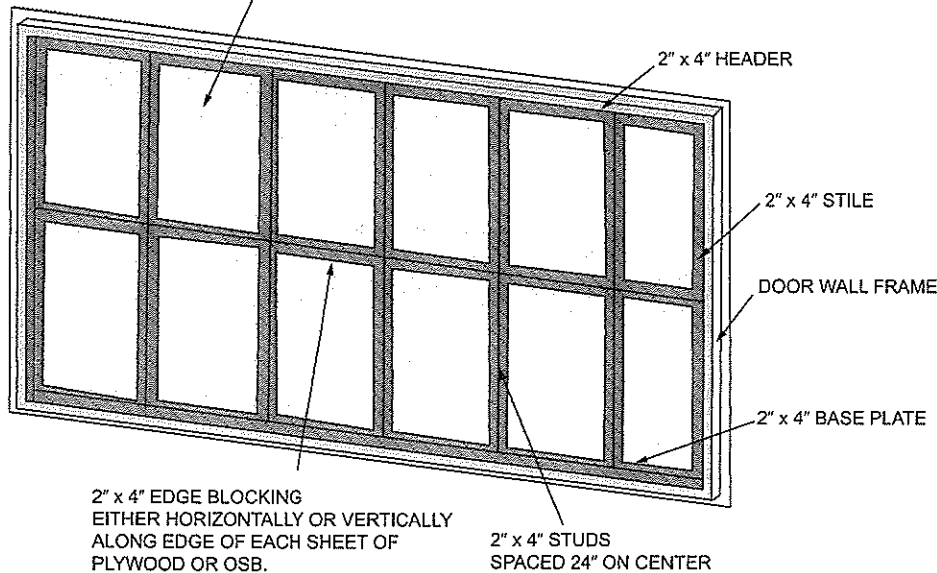

For SI: 1 inch = 25.4 mm.

**A103.2 Boarding sheet material.** The boarding sheet material shall be cut to fit the door or window opening neatly or shall be cut to provide an equal overlap at the perimeter of the door or window.

**A103.3 Windows.** The window shall be opened to allow the carriage bolt to pass through or the window sash shall be removed and stored. The 2-inch by 4-inch (51 mm by 102 mm) strong back framing material shall be cut minimum 2 inches (51 mm) wider than the window opening and shall be placed on the inside of the window opening 6 inches (152 mm) minimum above the bottom and below the top of the window opening. The framing and boarding shall be predrilled. The assembly shall be aligned and the bolts, washers and nuts shall be installed and secured.

**A103.4 Door walls.** The door opening shall be framed with minimum 2-inch by 4-inch (51 mm by 102 mm) framing material secured at the entire perimeter and vertical members at a maximum of 24 inches (610 mm) on center. Blocking shall also be secured at a maximum of 48 inches (1219 mm) on center vertically. Boarding sheet material shall be secured with screws and nails alternating every 6 inches (152 mm) on center.

**A103.5 Doors.** Doors shall be secured by the same method as for windows or door openings. One door to the *structure* shall be available for authorized entry and shall be secured and locked in an *approved* manner.

## SECTION A104—REFERENCED STANDARD

**A104.1 Referenced standards.** Table A104.1 lists the standard that is referenced in various sections of this appendix. The standard is listed herein by the standard identification, the effective date and title and the section or sections of this document that reference the standard. The application of the referenced standards shall be as specified in Section 102.8.

TABLE A104.1—REFERENCED STANDARD

STANDARD ACRONYM	STANDARD NAME	SECTIONS HEREIN REFERENCED
IBC-24	<i>International Building Code</i>	A102.1, A102.2, A102.3

## APPENDIX

## B

## BOARD OF APPEALS

The provisions contained in this appendix are not mandatory unless specifically referenced in the adopting ordinance.

**User notes:**

**About this appendix:** Appendix B provides criteria for Board of Appeals members. Also provided are procedures by which the Board of Appeals should conduct its business.

**Code development reminder:** Code change proposals to this appendix will be considered by the Administrative Code Development Committee during the 2025 (Group B) Code Development Cycle.

**SECTION B101—GENERAL**

**B101.1 Scope.** A board of appeals shall be established within the jurisdiction for the purpose of hearing applications for modification of the requirements of this code pursuant to the provisions of Section 106 (Means of Appeals). The board shall be established and operated in accordance with this section, and shall be authorized to hear evidence from appellants and the *code official* pertaining to the application and intent of this code for the purpose of issuing orders pursuant to these provisions.

**B101.2 Application for appeal.** Any person shall have the right to appeal a decision of the *code official* to the board. An application for appeal shall be based on a claim that the intent of this code or the rules legally adopted hereunder have been incorrectly interpreted, the provisions of this code do not fully apply or an equally good or better form of construction is proposed. The application shall be filed on a form obtained from the *code official* within 20 days after the notice was served.

**B101.2.1 Limitation of authority.** The board shall not have authority to waive requirements of this code or interpret the administration of this code.

**B101.2.2 Stays of enforcement.** Appeals of notice and orders, other than *Imminent Danger* notices, shall stay the enforcement of the notice and order until the appeal is heard by the board.

**B101.3 Membership of the board.** The board shall consist of five voting members appointed by the chief appointing authority of the jurisdiction. Each member shall serve for [INSERT NUMBER OF YEARS] years or until a successor has been appointed. The board member's terms shall be staggered at intervals, so as to provide continuity. The *code official* shall be an ex officio member of said board but shall not vote on any matter before the board.

**B101.3.1 Qualifications.** The board shall consist of five individuals, who are qualified by experience and training to pass on matters pertaining to building construction and are not employees of the jurisdiction.

**B101.3.2 Alternate members.** The chief appointing authority is authorized to appoint two alternate members who shall be called by the board chairperson to hear appeals during the absence or disqualification of a member. Alternate members shall possess the qualifications required for board membership, and shall be appointed for the same term or until a successor has been appointed.

**B101.3.3 Vacancies.** Vacancies shall be filled for an unexpired term in the same manner in which original appointments are required to be made.

**B101.3.4 Chairperson.** The board shall annually select one of its members to serve as chairperson.

**B101.3.5 Secretary.** The chief appointing authority shall designate a qualified clerk to serve as secretary to the board. The secretary shall file a detailed record of all proceedings which shall set forth the reasons for the board's decision, the vote of each member, the absence of a member and any failure of a member to vote.

**B101.3.6 Conflict of interest.** A member with any personal, professional or financial interest in a matter before the board shall declare such interest and refrain from participating in discussions, deliberations and voting on such matters.

**B101.3.7 Compensation of members.** Compensation of members shall be determined by law.

**B101.3.8 Removal from the board.** A member shall be removed from the board prior to the end of their terms only for cause. Any member with continued absence from regular meeting of the board may be removed at the discretion of the chief appointing authority.

**B101.4 Rules and procedures.** The board shall establish policies and procedures necessary to carry out its duties consistent with the provisions of this code and applicable state law. The procedures shall not require compliance with strict rules of evidence, but shall mandate that only relevant information be presented.

**B101.5 Notice of meeting.** The board shall meet upon notice from the chairperson, within 10 days of the filing of an appeal or at stated periodic intervals.

**B101.5.1 Open hearing.** All hearings before the board shall be open to the public. The appellant, the appellant's representative, the *code official* and any person whose interests are affected shall be given an opportunity to be heard.



## APPENDIX B—BOARD OF APPEALS

**B101.5.2 Quorum.** Three members of the board shall constitute a quorum.

**B101.5.3 Postponed hearing.** When five members are not present to hear an appeal, either the appellant or the appellant's representative shall have the right to request a postponement of the hearing.

**B101.6 Legal counsel.** The jurisdiction shall furnish legal counsel to the board to provide members with general legal advice concerning matters before them for consideration. Members shall be represented by legal counsel at the jurisdiction's expense in all matters arising from service within the scope of their duties.

**B101.7 Board decision.** The board shall only modify or reverse the decision of the *code official* by a concurring vote of three or more members.

**B101.7.1 Resolution.** The decision of the board shall be by resolution. Every decision shall be promptly filed in writing in the office of the *code official* within three days and shall be open to the public for inspection. A certified copy shall be furnished to the appellant or the appellant's representative and to the *code official*.

**B101.7.2 Administration.** The *code official* shall take immediate action in accordance with the decision of the board.

**B101.8 Court review.** Any *person*, whether or not a previous party of the appeal, shall have the right to apply to the appropriate court for a writ of certiorari to correct errors of law. Application for review shall be made in the manner and time required by law following the filing of the decision in the office of the chief administrative officer.

# INDEX

- Access**
  - Emergency egress 702
  - From bedrooms 404.4.2
  - Plumbing fixtures, access for cleaning 504.2
  - To public way 702.1
  - Toilet room as passageway 503.1
  - Water closet 404.4.3
- Adjacent**
  - Privacy (hotel units, rooming units) 404.1
- Administration**
  - Scope 101.2
- Air**
  - Combustion air 603.5
- Aisles**
  - Minimum width 702.2
- Alteration**
  - Applicability of other codes 102.3
  - Inspection 105.2
  - Prosecution 107.3
  - Unlawful acts 107.1
- Anchor**
  - Anchored, definition 202
  - Architectural trim 304.8
  - Signs, marquees and awnings 304.9
  - Unsafe conditions 304.1.1
- Anchored** 202, 304.1.1, 305.1.1
- Appeal**
  - Application 106.2
  - Board of appeals 108.1
  - Hearing, emergency orders 110.6
  - Membership 108.1
  - Notice of appeal 106.2
  - Records 105.6
  - Right to appeal 106.2
- Appliance**
  - Cooking 403.3, 602.2
  - Mechanical 603.1
- Applicability**
  - Application of references 102.10
  - General 102.1
  - Other laws 102.11
  - Referenced codes and standards 102.8
- Approval**
  - Alternatives 105.2.2
  - Authority 105.1, 105.2.2
  - Modifications 105.2.3
  - Research reports 105.2.2.6
  - Used material and equipment 105.8.1
- Approved**
  - Alternative materials, methods and equipment 105.2.2
  - Definition 202
  - Energy conservation devices 603.6
  - Garbage storage facilities 308.3.1
  - Modifications 105.2.3
  - Used materials and equipment 105.8.1
- Artificial**
  - Lighting of habitable rooms 401.3
  - Lighting of other spaces 402.3
- Automobile**
  - Motor vehicles 302.8
- Awning**
  - Signs, marquees and awnings 304.9
- Balcony**
  - Handrails and guardrails 304.12
- Basement**
  - Definition 202
  - Hatchways 304.16
  - Windows 304.17
- Bathroom**
  - Common bathrooms 502.3, 503.1
  - Hotels 502.3
  - Lighting 605.3
  - Locks 503.1
  - Outlets required 605.2
  - Privacy 503.1
  - Ventilation 403.2
- Bathtub**
  - Dwelling units 502.1
  - Rooming houses 502.2
  - Sewage system 506.1
  - Water system 505.1
  - Water-heating facilities 505.4
- Bedroom** 202
- Boarding**
  - Boarding standard Appendix A
- Boiler**
  - Unsafe equipment 109.1.2
- Capacity**
  - Heating facilities 602.2, 602.3, 602.4
- Carbon Monoxide Alarms and Detection**
  - Installation 705.1
  - Maintenance 705.2
- Ceiling**
  - Basement rooms 404.3
  - Fire-resistance ratings 703.1
  - Interior surfaces 305.3
  - Minimum height 404.3
  - Sleeping rooms 404.3
- Change, Modify**
  - Application of other codes 102.3
- Chimney**
  - Exterior structure 304.11
  - Flue 603.2, 603.3
- Cleaning**
  - Access for cleaning 504.2
  - Disposal of garbage 308.3
  - Disposal of rubbish 308.2
  - Interior and exterior sanitation 308.1
  - Interior surfaces 305.3
  - Plumbing facilities, maintained 504.1
  - Required plumbing facilities 502
  - Responsibility of persons 305.1
  - Trash containers 308.3.2
  - Vacant structures and land 301.3
- Clearance**
  - Heating facilities 603.3
  - Plumbing fixtures 504.2
- Closing**
  - Streets 110.3
  - Vacant structures 109.2
- Clothes Dryer**
  - Exhaust 403.5
- Code Official**
  - Condemnation 109.1
  - Demolition 111
  - Duties 105
  - Emergency order 110
  - Enforcement authority 105.1
- Failure to comply with demolition order 111.3
- Identification 105.3
- Inspections 105.2
- Liability, relief of personal 105.7
- Membership of board of appeals 108.1
- Notice of violation 105.5, 106
- Official records 105.6
- Personal liability 105.7
- Placarding 109.7
- Prosecution 107.3
- Removal of placard 109.7.1
- Right of entry 105.3
- Transfer of ownership 109.6
- Vacant structures 109.2
- Voting of appeals board 108.1
- Combustion**
  - Combustion air 603.5
- Component Serviceability**
  - Unsafe conditions 306.1.1
- Condemn** 109.1, 109.2, 109.4, 109.7, 109.7.1, 109.8, 202
- Condemnation**
  - Closing of vacant structures 109.2
  - Failure to comply 111.3
  - General 109.1
  - Notices and orders 109.2, 109.3
  - Placarding 109.7
  - Removal of placard 109.7.1
- Conflict**
  - Conflict of interest 109.1.3
  - Violations 107.1
- Connection**
  - Sewage system 506.1
  - Water heating 505.4
  - Water system 505.1
- Construction**
  - Existing structures 101.2
- Container**
  - Garbage 308.3.2
  - Rubbish storage 308.2.1
- Continuous**
  - Unobstructed egress 702.1
- Control**
  - Rodent control 302.5, 304.5
  - Safety controls 603.4
  - Weed 302.4
- Cooling**
  - Cooling towers 304.11
- Corridor**
  - Accumulation of rubbish 308.1
  - Light 402.2
  - Lighting fixtures 605.3
  - Obstructions 702.1, 702.2
  - Ratings maintained 703
- Cost of Such Demolition or Emergency Repairs** 202
- Damp, Dampness**
  - Roofs 304.7
  - Window, door frames 304.13
- Dangerous** 102.4, 109.1.1, 110.1, 111.1, 202
- Dangerous, Hazardous**
  - Condemnation 109.1
  - Demolition 111
  - Electrical hazards 604.3, 604.3.1
  - Existing remedies 102.4

## INDEX

- Imminent danger 202
- Unsafe equipment 109.1.2
- Unsafe structures or premises 109.1.5
- Decks**
  - Handrails and guardrails 304.12
  - Maintenance 304.2, 304.10
- Demolition**
  - Existing remedies 102.4
  - Failure to comply 111.3
  - General 111
  - Order 111.2
  - Salvage materials 111.4
- Detached** 109.1.5, 202, 306.1.1
- Detectors**
  - Smoke 704
- Deterioration**
  - Components of systems 306.1.1
  - Definition 202
  - Exterior structure 304.1.1
  - Exterior walls 304.6
- Direct**
  - Egress 702.1
- Disposal**
  - Disposal of garbage 308.3
  - Disposal of rubbish 308.2
- Door**
  - Exit doors 702.3
  - Fire 703.2
  - Hardware 304.15
  - Insect screens 304.14
  - Interior surfaces 305.3
  - Locks 304.15, 702.3
  - Maintenance 304.13, 304.15
  - Weather tight 304.13
  - Window and door frames 304.13
- Dormitory (Rooming House, Hotel, Motel)**
  - Locked doors 702.3
  - Privacy 503.1, 503.2
- Draft Stopping**
  - Maintenance 703.3.1
- Drain, Drainage**
  - Basement hatchways 304.16
  - Plumbing connections 506
  - Storm drainage 507
- Duct**
  - Duct systems 607
  - Exhaust duct 304.9
- Dust**
  - Process ventilation 403.4
- Dwelling**
  - Cleanliness 305.1, 308.1
  - Definition 202
  - Electrical 604.1
  - Heating facilities 602
  - Required facilities 502
- Dwelling Unit** 202
- Easement** 202
- Egress**
  - Aisles 702.2
  - Emergency escape 702.4
  - General 702.1
  - Lighting 402.2
  - Locked doors 702.3
  - Obstructions prohibited 702.1
  - Stairs, porches and railings 304.10, 305.4, 305.5, 307.1
- Electric, Electrical Equipment**
  - Abatement of hazards, fire exposure 604.3.2
  - Abatement of hazards, water exposure 604.3.1
  - Condemnation 109.1
  - Electrical equipment 604.3.1.1
  - Facilities required 604.1
  - Hazards 604.3
  - Installation 605.1
  - Lighting fixtures 605.3
  - Receptacles 604.3, 605.2
  - Responsibility 601.2
  - Service 604.2
- Elevator, Escalators, Dumbwaiters**
  - Condemnation 109.1
  - General 606.1
  - Maintenance 606.1, 606.2
- Emergency**
  - Emergency escape openings 702.4
  - Emergency measures 110
  - Emergency Orders 110.1
- Emergency Escape and Rescue Opening** 202, 702.4
- Enforcement**
  - Duties and powers 105
  - Scope 101.2
- Equipment**
  - Alternative 105.2.2
  - Combustion air 603.5
  - Condemnation 109.1.2, 109.3
  - Electrical installation 605.1
  - Emergency order 110.1
  - Energy conservation devices 603.6
  - Installation 603.1
  - Interior structure 305.1
  - Placarding 109.7, 109.8
  - Prohibited use 109.8
  - Responsibility 601.2
  - Safety controls 603.4
  - Scope 101.2
  - Scope, mechanical and electrical 601.1
  - Support, definition 202
  - Unsafe 109.1.2
  - Used 105.8.1
- Equipment Support** 202
- Exhaust**
  - Clothes dryer 403.5
  - Exhaust ducts 304.9
  - Process ventilation 403.4
- Existing**
  - Remedies 102.4
  - Scope 101.2
  - Structural members 304.1.1, 304.4
  - Structures 101.3
- Exterior**
  - Decorative features 304.8
  - Exterior structure 304
  - Exterior walls 304.6
  - Painting 304.2, 304.6
  - Rodent harborage 302.5, 304.5
  - Sanitation 304.1
  - Scope 301.1
  - Stair 304.10
  - Street numbers 304.3
  - Unsafe conditions 304.1.1
  - Weathertight 304.13
- Exterior Property** 202, 301.1, 302
- Fan**
  - Exhaust vents 302.6
- Fees, Expenses, Cost**
  - Closing vacant structures 109.2
  - Demolition 111.1, 111.3, 111.4
  - Extermination 309.2, 309.3, 309.4, 309.5
  - General 104.1
  - Relief from personal liability 105.7
- Fence**
  - Accessory 302.7
  - Maintenance 304.2
- Fire**
  - Blocking maintenance 703.3.1
- Fire Department**
  - Connection access 704.5.1, 704.5.2
  - Connections 704.5
- Fire Protection Systems**
  - Emergency impairments 704.3.1
  - Equipment 704.4, 704.4.1, 704.4.2
  - Inspection 704.1, 704.1.3, 704.2
  - Installation 704.1.1
  - Maintenance 704.1, 704.1.3, 704.2
  - Out of service 704.3
  - Records of maintenance 704.2.1
  - Required systems 704.1.2, 704.2.2
  - Smoke alarms 704.6
  - Smoke detections systems 704.6.4
  - Termination of service 704.4.3
  - Testing 704.1, 704.1.3, 704.2
- Fire-Resistance Ratings**
  - Ceilings 703.5
  - Draft stopping 703.3.1
  - Fire barriers 703.3.3
  - Fire blocking 703.3.1
  - Fire partitions 703.3.3
  - Fire walls 703.3.3
  - Maintenance 703.3
  - Opening protective 703.4
  - Shafts 703.7
  - Smoke barriers 703.3.2
  - Smoke partitions 703.3.2
  - Unsafe conditions 703.2
- Flammable Liquid**
  - Containers 109.1.2
- Floor, Flooring**
  - Area for sleeping purposes 404.4.1
  - Fire-resistance ratings 703.1
  - Interior surfaces 305.1, 305.3
  - Space requirements 404.4.1, 404.6
- Food Preparation**
  - Cooking equipment 403.3
  - Sanitary condition 305.1, 404.7
  - Ventilation 403.4
- Foundation**
  - Condemnation 109.1.1
  - Foundation walls 304.5
  - Unsafe conditions 304.1.1, 305.1.1
- Frame**
  - Window and door frames 304.13
- Garbage** 308
- Gas**
  - Energy conservation devices 603.6
  - Exhaust vents 302.6
- Glazing**
  - Materials 304.13.1
- Grade**
  - Drainage 302.2, 507

- Guard**
  - Anchorage and maintenance 304.12
  - Basement windows 304.18.2
  - Definition 202
- Habitable**
  - Definition 202
  - Light 402
  - Minimum ceiling height 404.3
  - Minimum room width 404.2
  - Required plumbing facilities 502
  - Residential heating facilities 602.2, 602.3
  - Space requirements 404.4.1
  - Ventilation 403
- Habitable Space** 402.1, 403.1, 404.4.2, 605.2
- Handrails and Guardrails**
  - Handrails 304.12, 305.5, 307.1
  - Stairs and porches 304.10
- Hardware**
  - Door hardware 304.15, 702.3
  - Openable windows 304.13.2
- Heat, Heating**
  - Energy conservation devices 603.6
  - Fireplaces 603.1
  - Heating 603.1
  - Mechanical equipment 603.1
  - Required capabilities 602
  - Residential heating 602.2, 602.3
  - Supply 602.3
  - Water heating facilities 505.4
  - Water system 505
- Height**
  - Minimum ceiling height 404.3
- Historic Building**
- Hotels, Rooming Houses and Dormitory Units, Motels**
  - Definition 202
  - Locked doors 702.3
  - Required facilities 502
  - Toilet rooms 503
- Housekeeping Unit**
  - Definition 202
- Identification**
  - Code official 105.4
- Imminent Danger** 110.1, 703.2, B101.2.2
- Infestation**
  - Condemnation 109.1.3
  - Definition 202
  - Insect and rodent 302.5, 304.14, 309.1
- Inoperable Motor Vehicle** 202
- Insects**
  - Infestation 309.1
  - Insect screens 304.14
  - Pest elimination 309
- Inspections**
  - General 105.2
  - Right of entry 105.3
- Inspector**
  - Identification 105.4
  - Inspection 105.2
  - Records 105.6
- Intent**
  - Code 101.3
- Interior**
  - Interior structure 305
  - Interior surfaces 305.3
  - Means of egress 702
- Sanitation 305.1
- Unsafe conditions 305.1.1
- Jurisdiction**
  - Title 101.1
- Kitchen**
  - Electrical outlets required 605.2
  - Minimum width 404.2
  - Prohibited use 404.4.4
  - Room lighting 605.3
  - Water heating facilities 505.4
- Labeled** 202, 403.5, 603.2, 603.6
- Landing**
  - Handrails and guards 304.12, 305.5, 306.1
  - Maintenance 304.10, 305.4
- Laundry**
  - Room lighting 605.3
  - Water-heating facilities 505.4
- Lavatory**
  - Hotels 502.3
  - Required facilities 502
  - Rooming houses 502.2
  - Sanitary drainage system 506
  - Water system 505
  - Water-heating facilities 505.4
- Lease (Sell, Rent)**
  - Heat supplied 602.3
  - Salvage materials 111.4
  - Transfer of ownership 109.6
- Let for Occupancy or Let** 202
- Lien**
  - Closing of vacant structures 109.2
  - Demolition 111.3
  - Failure to comply 111.3
- Light, Lighting**
  - Common halls and stairways 402.2, 605.3
  - General 402
  - Habitable rooms 402.1
  - Kitchen 605.3
  - Laundry rooms 605.3
  - Luminaires 605.3
  - Other spaces 402.3
  - Responsibility 401.2
  - Scope 101.2
  - Toilet rooms 605.3
- Living Room**
  - Room area 404.4.1
- Load, Loading**
  - Elevators, escalators and dumbwaiters 606.1
  - Handrails and guardrails 304.12, 305.5
  - Live load 304.4, 305.2
  - Stairs and porches 304.10, 305.2
  - Structural members 304.4, 305.2
- Maintenance**
  - Required 102.2
- Material**
  - Alternative 105.2.2
  - Salvage 111.4
  - Used 105.8.1
- Means of Egress** 109.1.5, 304.15, 402.2, 702.1, 702.3, 704.6.1.1
- Mechanical**
  - Installation 603.1
- Responsibility 601.2
- Scope 601.1
- Ventilation, general 403
- Ventilation, toilet rooms 403.2
- Minimum**
  - Ceiling height 404.3
  - Room area 404.4.1
  - Room width 404.2
- Modification**
  - Approval 105.2.3
- Motor Vehicles**
  - Inoperative 302.8
  - Painting 302.8
- Natural**
  - Lighting 401.3, 402
  - Ventilation 401.3, 403
- Neglect** 109.1.5, 202
- Notices and Orders**
  - Appeal 106.2
  - Form 109.4.1
  - Method of service 109.4.2
  - Orders 106
  - Owner, responsible person 109.4
  - Placarding of structure 109.7
  - Transfer of ownership 109.6
  - Unauthorized tampering 109.5
  - Vacating structure 109.2
- Noxious**
  - Process ventilation 403.4
  - Weeds 302.4
- Nuisance**
  - Closing of vacant structures 109.2
- Obstruction**
  - Light 402.1
  - Right of entry 105.3
- Occupancy** 202
- Occupant**
- Openable**
  - Locked doors 702.3
  - Windows 304.13.2, 403.1
- Openable Area** 202, 403.1
- Opening Protectives**
  - Closers 703.8
  - Door operation 703.4.3
  - Hold-open devices 703.4.2
  - Maintenance 703.4
  - Signs 703.4.1
  - Testing 703.6
- Operator**
  - Definition 202
- Ordinance, Rule**
  - Applicability 102
  - Application for appeal 106.2
- Outlet**
  - Electrical 605.2
- Owner**
  - Closing of vacant structures 109.2
  - Definition 202
  - Demolition 111
  - Failure to comply 111.3
  - Insect and rat control 302.5, 309.2, 309.4
  - Notice 109.4, 109.3
  - Pest elimination 309.2
  - Placarding of structure 109.7
  - Responsibility 301.2
  - Responsibility, fire safety 701.2

## INDEX

- Responsibility, light, ventilation 401.2
- Responsibility, mechanical and electrical 601.2
- Responsibility, plumbing facilities 501.2
- Right of entry 105.3
- Rubbish storage 308.2.1
- Scope 101.2
- Transfer of ownership 109.6
- Passageway**
  - Common hall and stairway 402.2
  - Interior surfaces 305.3
  - Toilet rooms, direct access 503.1
- Peer Review** 105.2.2.7, 202
- Penalty**
  - Placarding of structure 109.7
  - Prohibited occupancy 109.8
  - Removal of placard 109.7.1
  - Scope 101.2
  - Violations 107.4
- Person** 202
- Pest Elimination**
  - Condemnation 109.1
  - Definition 202
  - Insect and rodent control 302.5, 304.5, 304.14, 309.1
  - Pest elimination 309.1
  - Responsibility of owner 301.2, 309.2
  - Responsibility of tenant-occupant 309.3, 309.4, 309.5
- Placard, Post**
  - Closing 109.2
  - Condemnation 109.1
  - Demolition 111
  - Emergency, notice 110.1
  - Notice to owner 109.4, 109.3
  - Placarding of structure 109.7
  - Prohibited use 109.8
  - Removal 109.7.1
- Plumbing**
  - Clean and sanitary 504.1
  - Clearance 504.2
  - Connections 505.1
  - Contamination 505.2
  - Employee's facilities 503.3
  - Fixtures 504.1
  - Required facilities 502
  - Responsibility 501.2
  - Sanitary drainage system 506
  - Scope 501.1
  - Storm drainage 507
  - Supply 505.3
  - Water heating facilities 505.4
- Porch**
  - Handrails 304.12
  - Structurally sound 304.10
- Portable (Temporary)**
  - Cooking equipment 603.1
- Power Safety Cover** 202, 303.2
- Premises** 202
- Pressure**
  - Water supply 505.3
- Private, Privacy**
  - Bathtub or shower 503.1
  - Occupancy limitations 404.1
  - Required plumbing facilities 502
  - Sewage system 506.1
  - Water closet and lavatory 503.1
- Water system 505.1
- Property, Premises**
  - Cleanliness 304.1, 308.1
  - Condemnation 109
  - Definition 202
  - Demolition 111
  - Emergency measures 110
  - Exterior areas 302
  - Failure to comply 111.3
  - Grading and drainage 302.2
  - Pest elimination, multiple occupancy 302.5, 309.4
  - Pest elimination, single occupancy 302.5, 309.3
  - Responsibility 301.2
  - Scope 301.1
  - Storm drainage 507
  - Vacant structures and land 301.3
- Protection**
  - Basement windows 304.17
  - Fire protection systems 704
  - Signs, marquees and awnings 304.9
- Public**
  - Cleanliness 304.1, 305.1
  - Egress 702.1
  - Hallway 502.3
  - Sewage system 506.1
  - Toilet facilities 502.5, 503
  - Vacant structures and land 301.3
  - Water system 505
- Public Way**
  - Definition 202
- Rain (Prevention of Entry into Building Exterior Envelope)**
  - Basement hatchways 304.16
  - Exterior walls 304.6
  - Grading and drainage 302.2
  - Roofs 304.7
  - Window and door frames 304.13
- Record**
  - Official records 105.6
- Repair**
  - Application of other codes 102.3
  - Chimneys 304.11
  - Demolition 111.1
  - Exterior surfaces 304.1
  - Intent 101.3
  - Maintenance 102.2
  - Signs, marquees and awnings 304.9
  - Stairs and porches 304.10
  - Weathertight 304.13
  - Workmanship 102.5
- Reports**
  - Test reports 105.6.4
- Residential**
  - Pest elimination 309
  - Residential heating 602.2
  - Scope 101.2
- Responsibility**
  - Fire safety 701.2
  - Garbage disposal 308.3
  - General 301.2
  - Mechanical and electrical 601.2
  - Persons 301.1
  - Pest elimination 309
  - Placarding of structure 109.7
  - Plumbing facilities 501.2
  - Rubbish storage 308.2.1
- Scope 101.2, 301.1
- Revoke, Remove**
  - Demolition 111
  - Existing remedies 102.4
  - Removal of placard 109.7.1
  - Rubbish removal 308.2.1
- Right of Entry**
  - Duties and powers of code official 105.3
  - Inspections 105.2
- Rodents**
  - Basement hatchways 304.16
  - Condemnation 109
  - Foundations 304.5
  - Guards for basement windows 304.17
  - Harborage 302.5
  - Insect and rodent control 309.1
  - Pest elimination 302.5, 309
- Roof**
  - Exterior structure 304.1
  - Roofs 304.7
  - Storm drainage 507
- Room**
  - Bedroom and living room 404.4
  - Cooking facilities 403.3
  - Direct access 503.2
  - Habitable 402.1
  - Heating facilities 602
  - Light 402
  - Minimum ceiling heights 404.3
  - Minimum width 404.2
  - Overcrowding 404.5
  - Prohibited use 404.4.4
  - Temperature 602.5
  - Toilet 503
  - Ventilation 403
- Rooming House** 202
- Rooming Unit** 202
- Rubbish**
  - Accumulation 308.1
  - Definition 202
  - Disposal 308.2
  - Garbage facilities 308.3.1
  - Rubbish storage 308.2.1
- Safety, Safe**
  - Fire safety requirements 701, 702, 703, 704
  - Safety controls 603.4
- Safety Cover** 202, 303.2
- Sanitary**
  - Cleanliness 304.1, 305.1
  - Disposal of garbage 308.3
  - Disposal of rubbish 308.2
  - Exterior property areas 302.1
  - Exterior structure 304.1
  - Food preparation 404.7
  - Furnished by occupant 302.1
  - Grease interceptors 506.3
  - Interior surfaces 305.3
  - Plumbing fixtures 504.1
  - Required plumbing facilities 502
  - Scope 101.2
- Screens**
  - Insect screens 304.14
- Security**
  - Basement hatchways 304.18.3
  - Building 304.18
  - Doors 304.18.1

- Vacant structures and land 301.3
- Windows 304.18.2
- Self-Closing Screen Doors**
- Insect screens 304.14
- Separation**
- Fire-resistance ratings 703
- Privacy 404.1
- Separation of units 404.1
- Service**
- Electrical 604.2
- Method 109.4.2
- Notices and orders 109.4, 109.3
- Service on occupant 109.3
- Sewer**
- General 506.1
- Maintenance 506.2
- Shower**
- Bathtub or shower 502.1
- Rooming houses 502.2
- Water system 505
- Water-heating facilities 505.4
- Sign**
- Fire door signs 703.4.1
- Signs, marquees and awnings 304.9
- Unauthorized tampering 109.5
- Single-Family Dwelling**
- Extermination 309
- Sink**
- Kitchen sink 502.1
- Sewage system 506
- Water supply 505.3
- Size**
- Efficiency unit 404.6
- Habitable room, light 402
- Habitable room, ventilation 403
- Room area 404.4.1
- Smoke Alarms**
- Group R-1 704.6.1.1
- Groups R-2, R-3, R-4 and I-1 704.6.1.2
- Installation near bathrooms 704.6.1.4
- Installation near cooking appliances 704.6.1.3
- Interconnection 704.6.2
- Power source 704.6.3
- Testing 704.7
- Where required 704.6.1
- Space**
- General, light 402
- General, ventilation 403
- Occupancy limitations 404
- Privacy 404.1
- Scope 401.1
- Stack**
- Smoke 304.11
- Stairs**
- Common halls and stairways, light 402.2
- Exit facilities 305.4
- Exterior property areas 302.3
- Handrails 304.12, 305.5
- Lighting 605.3
- Stairs and porches 304.10
- Standard**
- Referenced 102.8
- Stop Work Order**
- Authority 108.1
- Emergencies 108.3
- Failure to comply 108.4
- Issuance 108.2
- Storage**
- Food preparation 404.7
- Garbage storage facilities 308.3
- Rubbish storage facilities 308.2.1
- Sanitation 308.1
- Storm Shelter** 202, 311
- Strict Liability Offense** 107.3, 202
- Structure**
- Accessory structures 302.7
- Closing of vacant structures 109.2
- Definition 202
- Emergency measures 110
- General, condemnation 111
- General, exterior 304.1
- General, interior structure 305.1
- Placarding of structure 109.7
- Scope 301.1
- Structural members 304.4, 305.2
- Vacant structures and land 301.3
- Supply**
- Combustion air 603.5
- Public water system 505.1
- Water supply 505.3
- Water system 505
- Water-heating facilities 505.4
- Surface**
- Exterior surfaces 304.2, 304.6
- Interior surfaces 305.3
- Swimming**
- Enclosure 303.2
- Safety covers 303.2
- Swimming pools 303.1
- Temperature**
- Nonresidential structures 602.4
- Residential buildings 602.2
- Water-heating facilities 505.4
- Tenant**
- Scope 101.2
- Test, Testing**
- Agency 105.2.1.4
- Methods 105.2.1.4
- Reports 105.6.4
- Required 106.3
- Toilet Room** 202, 403.2, 404.3, 503
- Toxic**
- Process ventilation 403.4
- Trash**
- Rubbish and garbage 308
- Ultimate Deformation** 202, 306.1.1
- Unobstructed**
- Access to public way 702.1
- General, egress 702.1
- Unsafe Structures and Equipment**
- Abatement methods 109.9
- Dangerous structure or premises 109.1.5
- Equipment 109.1.2
- Existing remedies 102.4
- General, condemnation 109, 111
- General, demolition 111
- Notices and orders 106, 109.3
- Record 109.3
- Structures 109.1.1
- Use**
- Application of other codes 102.3
- General, demolition 111
- Utilities**
- Authority to disconnect 109.2.1
- Vacant**
- Abatement methods 109.9
- Authority to disconnect service utilities 109.2.1
- Closing of vacant structures 109.2
- Emergency measure 110
- Method of service 109.4.2, 109.3
- Notice to owner or to person responsible 106, 109.3
- Placarding of structure 109.7
- Record 109.3
- Vacant structures and land 301.3
- Vapor**
- Exhaust vents 302.6
- Vehicles**
- Inoperative 302.8
- Painting 302.8
- Vent**
- Exhaust vents 302.6
- Flue 603.2
- Plumbing hazard 504.3
- Ventilation**
- Clothes dryer exhaust 403.5
- Combustion air 603.5
- Definition 202
- General, ventilation 403
- Habitable rooms 403.1
- Process ventilation 403.4
- Recirculation 403.2, 403.4
- Toilet rooms 403.2
- Vermin**
- Condemnation 109
- Insect and rodent control 302.5, 309
- Vertical Shafts**
- Required enclosure 703.7
- Violation**
- Condemnation 109
- Enforcement 107.2
- General 107
- Notice 106, 109.3
- Placarding of structure 109.7
- Prosecution 107.3
- Separate offenses 107.4
- Strict liability offense 107.3, 202
- Transfer of ownership 109.6
- Walk**
- Sidewalks 302.3
- Wall**
- Accessory structures 302.7
- Exterior surfaces 304.2, 304.6
- Exterior walls 304.6
- Foundation walls 304.5
- General, fire-resistance rating 703.1
- Interior surfaces 305.3
- Outlets required 605.2
- Temperature measurement 602.5
- Waste**
- Disposal of garbage 308.3
- Disposal of rubbish 308.2
- Garbage storage facilities 308.3.1
- Water**
- Basement hatchways 304.16
- Connections 506.1
- Contamination 505.2
- General, sewage 506

**INDEX**

- General, storm drainage 507
- General, water system 505
- Heating 505.4
- Hotels 502.3
- Kitchen sink 502.1
- Nonpotable water reuse 505.5,  
505.5.1
- Required facilities 502
- Rooming houses 502.2
- Supply 505.3
- System 505
- Toilet rooms 503
- Water-heating facilities 505.4
- Weather, Climate**
  - Heating facilities 602
- Weeds**
  - Noxious weeds 302.4
- Width**
  - Minimum room width 404.2
- Window**
  - Emergency escape 702.4
  - Glazing 304.13.1
  - Guards for basement windows 304.17
  - Habitable rooms 402.1
  - Insect screens 304.14
  - Interior surface 305.3
  - Light 402
  - Openable windows 304.13.2
  - Toilet rooms 403.2
  - Ventilation 403
  - Weather tight 304.13
  - Window and door frames 304.13
- Workmanlike** 102.5, 202
- Workmanship**
  - General 102.5
- Yard** 202, 507.1

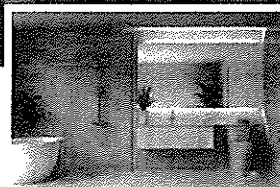

*Because Quality and Speed Matter*

# **Specify** and **Approve with Confidence**

**When facing new or unfamiliar materials, look for an ICC-ES Evaluation Report or Listing before approving for installation.**

ICC-ES® Evaluation Reports are the most widely accepted and trusted technical reports for code compliance.

ICC-ES Building Product Listings and PMG Listings show product compliance with applicable standard(s) referenced in the building and plumbing codes as well as other applicable codes.

When you specify or approve products or materials with an ICC-ES report, building product listing or PMG listing, you avoid delays on projects and improve your bottom line.

ICC-ES is a subsidiary of ICC®, the publisher of the codes used throughout the U.S. and many global markets, so you can be confident in their code expertise.



[icc-es.org](http://icc-es.org) | 800-423-6587



A Mark of Confidence™

A subsidiary of



INTERNATIONAL  
CODE  
COUNCIL



INTERNATIONAL  
CODE  
COUNCIL®

# Membership



At the heart of the International Code Council's rich history is our connection with our members. The Code Council and its members work together to create safer homes, buildings, and communities by promoting and maintaining the International Codes® (I-Codes®). Members benefit from top-notch professional development, innovative products and services, timely industry news, and valuable networking opportunities while lending their own expertise to the code development process.

## Membership Categories

Code officials, fire officials, architects, engineers, designers, and building safety professionals are all valued members of the Code Council. The Code Council offers several membership categories to meet your needs.

- **Government/Municipality** - Includes agencies, departments & units engaged in administration, formulation, implementation and/or enforcement of laws, ordinances, rules/regulations relating to public health, safety and welfare.
- **Corporate** - An organization such as an association, society, testing lab, institute, company, or manufacturer, interested in the purposes and objectives of the Code Council.
- **Individual**
  - › **Professional** – An individual who is interested in the purposes and objectives of the Code Council.
  - › **Participating** – An individual who participates in and supports the vision and mission of the organization. *Participating Members do not qualify for all member benefits.*
  - › **Student** - is enrolled in classes or an equivalent to at least 3 credit hours of classroom instruction per week.

## Member Benefits

As a member, you can expect nothing less than world-class service and invaluable benefits such as:

- Unlock the I-Codes with a Digital Codes Premium subscription (based on member category).
- Receive 10-25% off code books, specialized publications and training materials.
- Take advantage of discounts on expert training and educational programs so you can earn CEUs.
- Receive discounts on certification exams, exam resource materials and certification renewals.
- Showcase your membership with a digital badge on social media and your resume.
- Access technical support to answer your code-related questions (based on membership category).



Learn more about membership at  
[iccsafe.org/about-membership](https://iccsafe.org/about-membership)



Apply today at [iccsafe.org/join-icc](https://iccsafe.org/join-icc)



DIGITAL CODES  
PREMIUM®

codes.iccsafe.org



## Go Digital and Enhance Your Code Experience

ICC's Digital Codes Premium is the most trusted and authentic source of model codes and standards, which conveniently provides access to the latest code text from across the United States.

### Unlock Exclusive Tools and Features with Premium Complete



**Search** over 1,700 of the latest codes and standards from your desktop or mobile device.



**Saved Search** allows users to save search criteria for later use without re-entering.



**Organize Notes** and thoughts by adding personal notes, files or videos into relevant code sections.



**Copy, Paste, Print or PDF** any code section.



**Share Access** by configuring your license to share access and content simultaneously with others (code titles, section links, bookmarks and notes).



**Highlight and Annotate** any code book content to keep you organized.



**Advanced Search** narrows down your search results with multiple filters to identify codes sections more accurately.



**Bookmark** and tag any section or subsection of interest.

### Stay Connected on the Go with our New Premium Mobile App

- View content offline
- Download up to 15 code titles
- Utilize Premium tools and features



AVAILABLE ON  
App Store



AVAILABLE ON  
Google Play



Monthly and Yearly Premium Subscriptions are available for:  
International Codes® | State Codes | Standards | Commentaries

Start your **FREE 14-Day Premium trial** at [codes.iccsafe.org/trial](https://codes.iccsafe.org/trial)  
Learn how to use this powerful tool at [codes.iccsafe.org](https://codes.iccsafe.org)

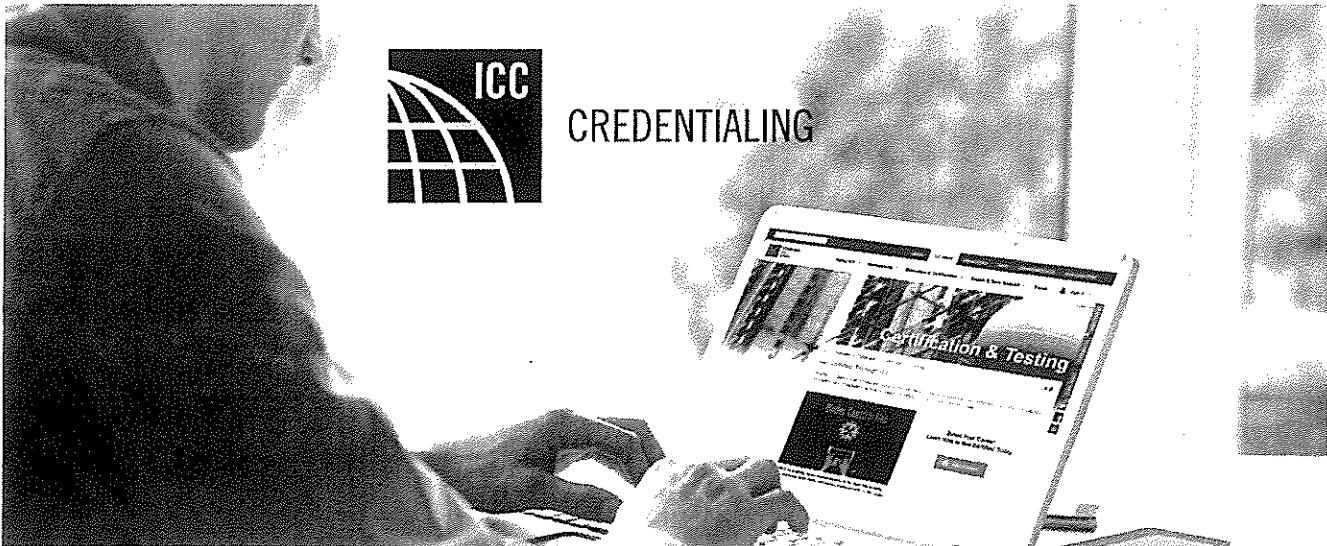

ICC Credentialing provides nationally recognized credentials that demonstrate a confirmed commitment to protect public health, safety, and welfare. Raise the professionalism of your department and further your career by pursuing an ICC Certification.

### ICC Certifications Offer

- Nationwide recognition
- Increased earning potential
- Career advancement
- Superior knowledge
- Validation of your expertise
- Personal and professional satisfaction

Exams are developed and maintained to the highest standards, which includes continuous peer review by national committees of experienced, practicing professionals.

### High Demand Exams (exam ID)

- Commercial Plumbing Inspector (P2)
- Plumbing Plans Examiner (P3)
- Commercial Mechanical Inspector (M2)
- Mechanical Plans Examiner (M3)
- Residential Building Inspector (B1)
- Commercial Building Inspector (B2)
- Building Plans Examiner (B3)
- Residential Electrical Inspector (E1)
- Commercial Electrical Inspector (E2)



Proctored Remote Online Testing Option (PRONTO) provides a convenient testing experience that is accessible 24 hours a day, 7 days a week, 365 days a year.

Required hardware/software is minimal – you will need a webcam and microphone, as well as a reasonably recent operating system.

Checkout all that ICC Credentialing has to offer at [iccsafe.org/certification](https://iccsafe.org/certification)

